

2

1

POWER REQUIREMENTS	VOLTS		AC 120 v @ 60Hz
	BATTERY BACKUP		4+ aa BATTERY 6v
LAMPS	LED 5v RGB		WS2811 DIODES
	IR REMOTE CONTROLLER		
	CUSTOMIZABLE WIFI APP		
PROFLAME II SYSTEM	5 LEVELS OF FLAME INTENSITY		
	REMOTE CONTROLLED IGNITION		
	VENTED CONFIGURATION		
HEATING OUTPUT	MAXIMUM HEAT	30,000 BTU/hr	8.75 kW
	MINIMUM HEAT (EN)	20,000 BTU/hr	5.85 kW
	MINIMUM HEAT (EP)	15,000 BTU/hr	4.39 kW

NOTE:
EN- NATURAL GAS
EP- PROPANE

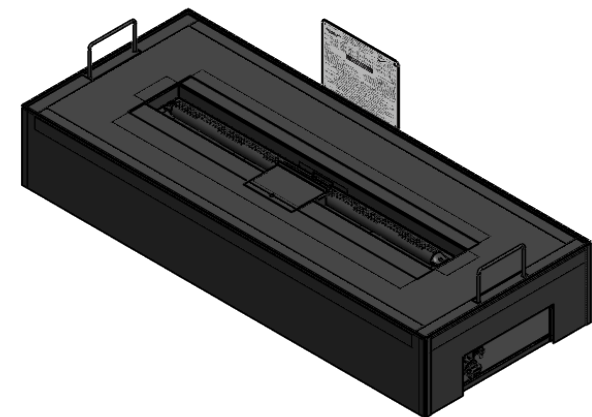

B

B

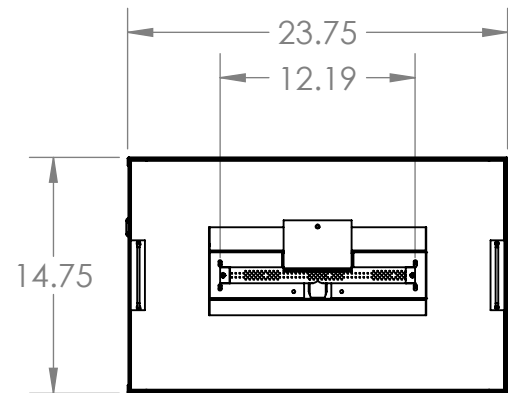

MINIMUM FIRE BOX DIM. (INCHES)		
WIDTH	DEPTH	HEIGHT
24.00	15.00	20.00

A

A

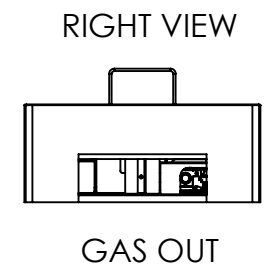
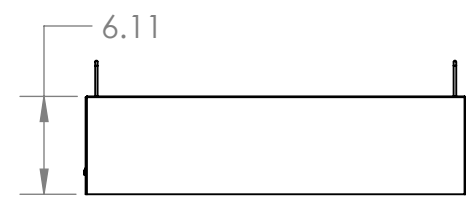
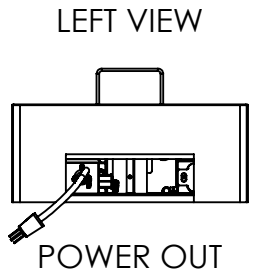

TITLE:
LINEAR DROP IN BURNER, VENTED
LDB24L-EP
LDB24L-EN

SIZE	DWG. NO.	REV
A	LDB-24L-XX	A
SCALE: N/A WEIGHT:		SHEET 1 OF 1

2

1