



# LAVA BURNER FRONT VIEW WITH GLOWFIRE™ LOGS

## INSTALLATION AND OPERATION MANUAL



SHOWN: 36" GLOWFIRE™ LAVA BURNER FRONT VIEW  
WITH ALL WEATHERED OAK CHARRED LOGS

### **WARNING**

**WARNING:** If the information in this manual is not followed exactly, a fire or explosion may result causing property damage, personal injury, or loss of life.

**FOR YOUR SAFETY:** Do not store or use gasoline or other flammable vapors and liquids in the vicinity of this or any other appliance.

#### **WHAT TO DO IF YOU SMELL GAS**

- Do not try to light any appliance.
- Do not touch any electrical switch; do not use any phone in your building.
- Immediately call your gas supplier from a neighbor's phone. Follow the gas supplier's instructions.
- If you cannot reach your gas supplier, call the fire department.
- Installation and service must be performed by a qualified installer, service agency, or the gas supplier.

**INSTALLER:** Leave this manual with appliance. **CONSUMER:** Retain this manual for future reference.



French Versions  
Versions Françaises  
Scan for French Manual  
Rechercher Français Manuel  
[GrandCanyonGasLogs.com/Resources](http://GrandCanyonGasLogs.com/Resources)

#### **FOR INDOOR OR OUTDOOR PATIO USE**

Certified to the Canadian and American National Standards: ANSI Z21.60-2017 / CSA 2.26-2017 for decorative gas appliances for installation in solid-fuel burning fireplaces.

## **Grand Canyon Gas Logs**

3515 East Atlanta Avenue, Phoenix, Arizona 85040 | 602-344-4217 | [grandcanyongaslogs.com](http://grandcanyongaslogs.com)



**⚠ WARNING**

- Do not operate appliance before reading and understanding operating instructions. Failure to operate appliance according to operating instructions could cause fire or injury.
- This appliance is hot when operated and can cause severe burns if contacted.
- Any changes or alterations to this appliance or its controls can be dangerous and is prohibited.
- Risk of fire or asphyxiation, do not operate appliance with safety screen removed and never obstruct the front opening of the appliance.
- Risk of burns. The appliance should be turned off and cooled before servicing.
- Do not install damaged, incomplete or substitute components.
- Risk of cuts and abrasions. Wear protective gloves, protective footwear, and safety glasses during installation. Sheet metal edges may be sharp.
- Do not burn wood or other materials in this appliance.
- Provide adequate ventilation and combustion air. Provide adequate accessibility clearance for servicing and operating the appliance.
- Children and adults should be alerted to hazards of high surface temperature and should stay away to avoid burns or clothing ignition.
- Young children should be carefully supervised when they are in the same room as the appliance. Toddlers, young children and others may be susceptible to accidental contact burns. A physical barrier is recommended if there are at-risk individuals in the house. To restrict access to an appliance or stove, install an adjustable safety gate to keep toddlers, young children and other at risk individuals out of the room and away from hot surfaces.
- Clothing or other flammable material should not be placed on or near the appliance.
- Due to high temperatures, the appliance should be located out of traffic and away from furniture and draperies.
- Furniture or other objects must be kept a minimum of 36 inches (.9144m) away from the front of the appliance.
- Ensure you have incorporated adequate safety measure to protect infants/toddlers from touching hot surfaces.
- Even after the appliance is off, it will remain hot for an extended period of time.
- Check with your local hearth specialty dealer for safety screens and hearth guards to protect children from hot surfaces. These screens and guards must be fastened to the floor.
- Any safety screen, guard or barrier removed for servicing the appliance, must be replaced prior to operating the appliance.
- A fireplace screen must be in place when the appliance is operating unless other provisions for combustion air are provided, the screen shall have openings for the introduction of combusted air.
- Thoroughly clean the chimney, flue and existing appliance before installing the new appliance into it. Do not burn solid fuels in any appliance that is equipped with this gas log set.
- The installation, including provisions for combustion, and ventilation air required minimum permanent vent opening must conform with the NATIONALS FUEL GAS CODE (ANSI Z223.1/NFPA 54) and applicable local building codes.
- Do not operate appliance in the presence of gasoline or other flammable liquids and vapors. Keep area clear of other combustible materials. The appliance and its shut off must be disconnected from the gas supply piping system before any pressure testing of the system is done.
- It is imperative that the control compartments, burners and circulating blower and its passageway in the appliance and venting system are kept clean. The appliance and its venting system should be inspected before use and at least annually by a qualified service person. More frequent cleaning may be required due to excessive lint from carpeting, bedding material, etc. The appliance area must be kept clear and free from combustible materials, gasoline, and other flammable vapors and liquids.
- If the appliance shuts off, do not relight until you provide fresh air. If appliance keeps shutting off, have it serviced. Keep burner and control compartment clean.
- Under no circumstances should this appliance be modified.
- Do not allow wind or fans to blow directly into the appliance. Avoid any drafts that alter burner flame patterns.
- Do not use a blower insert, heat exchanger insert or other accessory not approved for use with this appliance.
- This appliance must not be connected to a chimney flue pipe serving a separate solid fuel burning appliance.





## SAFETY INFORMATION

### **WARNING**

- Do not use this appliance if any part has been under water. Immediately call a qualified service technician to inspect the appliance and to replace any part of the control system and any gas control which has been under water.
- Keep the packaging material out of reach of children and dispose of the material in a safe manner. As with all plastic bags, these are not toys and should be kept away from children and infants.
- Carbon monoxide poisoning may lead to death; early signs of carbon monoxide poisoning resemble the flu, with headache, dizziness, and/or nausea. If you have these signs, the appliance may not be working properly. Get fresh air at once! Have appliance serviced. Some people; pregnant women, persons with heart or lung disease, anemia, those under the influence of alcohol, those at high altitudes are more affected by carbon monoxide than others. Failure to keep the primary air opening(s) of the burner(s) clean may result in sooting and property damage.
- As with any combustion appliance, we recommend having your appliance regularly inspected and serviced as well as having a Carbon Monoxide Detector installed in the same area to defend you and your family against Carbon Monoxide (not applicable for outdoor appliances).
- Ensure clearances to combustibles are maintained when building a mantel or shelves above the appliance. Elevated temperatures on the wall or in the air above the appliance can cause melting, discoloration or damage to decorations, a TV or other electronic components.
- **For appliances equipped with a safety barrier; if the barrier becomes damaged, the barrier shall be replaced with the manufacturer's barrier for this appliance.**
- **Installation and repair should be done by a qualified service person. It is imperative that control compartments, burners, and circulating air passageways of the appliance be kept clean.**
- For outdoor products only: this appliance must not be installed indoors or within any structure that prevents or inhibits the exhaust gases from dissipating in the outside atmosphere.
- Grab logs by the base with both hands. DO NOT use excessive force, slide off.
- Cracking and flaking of logs is normal with usage. Touch-up paint included with log set.

 **WARNING** Failure to position the parts in accordance with these diagrams or failure to use only parts specifically approved with this appliance may result in property damage or personal injury.

 **WARNING** This product can expose you to chemicals including lead and lead compounds, which are known to the State of California to cause cancer, and chemicals including carbon monoxide, which are known to the State of California to cause birth defects or other reproductive harm. For more information, go to [www.P65Warnings.ca.gov](http://www.P65Warnings.ca.gov).

 **WARNING** Improper installation, adjustment, service or maintenance can cause property damage, personal injury, or loss of life. Refer to the Owner's Information manual provided with this appliance. Installation and service must be performed by a qualified installer, service agency or the gas supplier.

 **WARNING** Vented Decorative Gas Appliance: Not a source of heat; Not for use with solid fuel. This appliance needs fresh air for safe operation and must be installed so there are provisions for adequate combustion and ventilation air.

 **WARNING** This appliance is NOT for installation in manufactured or mobile homes.

 **WARNING** Do not use the appliance if any part has been under water. Immediately call a qualified service technician to inspect the appliance and to replace any part of the control system and any gas control which has been under water.

### **WARNING**



#### **FIRE RISK HAZARD / DELAYED IGNITION**

High supply pressure will damage the valve / controls.

Disconnect the appliance main gas valve/control from the supply piping when pressure testing that system at pressures in excess of 1/2 psi (3.5 kPa).

Isolate the appliance with its shut off valve during any pressure testing of the supply piping at pressures equal to or less than 1/2 psi (3.5 kPa).

# TABLE OF CONTENTS

General Instructions and Information .....	4-7
Parts List .....	8-11
Wiring Diagram, Pre-Installation .....	12-14
Pre-Installation Steps .....	15-17
Installation Steps .....	18-19
Log Placement .....	20-28
Outdoor Installation Requirements .....	29-30
Multifunction Remote Operating Instructions .....	31-34
Remote Control Instructions .....	35-39
Intermittent Pilot Instructions .....	40
Battery Lighting Instructions .....	41
Maintenance .....	42
Troubleshooting .....	43-44
Warranty .....	45

NOTE: Changes, other than editorial, are denoted by a vertical line in the margin.

# GENERAL INSTRUCTIONS

**BATTERY-DEXEN**



3515 E. Atlanta Ave. Phoenix, AZ 85040  
07-00070

**DO NOT REMOVE THIS LABEL**

See installation & operating instructions for this model.  
Contact local building officials about restrictions and installation specifications in your area.

TESTED & LISTED BY:



ANSI Z21 60-2017  
CSA 2.26-2017  
Decorative gas appliances for installation in solid fuel burning fireplaces.

**C US**

REPORT # F29-187

	DATE OF MFG.	SERIAL #		
<b>MODEL: LAFV <input type="checkbox"/> EN</b>	<b>18</b> <input type="checkbox"/>	<b>24</b> <input type="checkbox"/>	<b>30</b> <input type="checkbox"/>	<b>36</b> <input type="checkbox"/>
HIGH BTU/HR (kW)	45,000 (13.19kW)	56,000 (16.41kW)	75,000 (21.98kW)	86,000 (25.20kW)
<b>MODEL: LAFV <input type="checkbox"/> EP</b>	<b>18</b> <input type="checkbox"/>	<b>24</b> <input type="checkbox"/>	<b>30</b> <input type="checkbox"/>	<b>36</b> <input type="checkbox"/>
HIGH BTU/HR (kW)	38,000 (11.14kW)	54,000 (15.83kW)	76,000 (22.73kW)	85,000 (24.91kW)

**NG Models**

Altitude  
Input  
Reduced Input  
P4  
Manifold Pressure: 3.5" w.c.(NG)  
Minimum Supply Pressure: 5" w.c.(NG)  
Maximum Supply Pressure: 10.5" w.c.(NG)  
Pression au Collecteur: .87wPA d'une colonne d'eau (GN)  
Pression d'Alimentation Min.: 1.25wPA d'une colonne d'eau (GN)  
Pression d'Alimentation Max.: 3.5wPA \*\* d'une colonne d'eau (GN) \*\*  
Maximum inlet pressure not to exceed 10.5".  
Minimum clearance to combustible materials: Top, sides & back.  
For non-combustible framing and finishing materials, see installation manual.

**MANIFOLD PRESSURE:**  
**ELECTRICAL RATING: 3V**  
**GAS TYPE: NATURAL GAS / LIQUID PROPANE**

**LP Models**

Elevation  
Alimentation / Alimentation Réduite  
P4  
Manifold Pressure: 10.5" w.c.(LP)  
Minimum Supply Pressure: 11" w.c.(LP)  
Max. Supply Pressure: 14" w.c.(LP)  
Pression au Collecteur: 2.40wPA d'une colonne d'eau (LP)  
Pression d'Alimentation Min.: 2.74wPA d'une colonne d'eau (LP)  
Pression d'Alimentation Max.: 3.5wPA \* d'une colonne d'eau (LP)  
\*\* Pression d'alimentation maximale ne devait pas dépasser 3.5wPA. Dégage ment minimum par rapport aux matériaux combustibles : Dessus, côtés et arrière : Pour les matériaux de charpente et de finition non combustibles, voir le manuel d'installation.

**⚠ WARNING VENTED DECORATIVE GAS APPLIANCE; NOT A SOURCE OF HEAT; NOT FOR USE WITH SOLID FUEL.**

**⚠ AVERTISSEMENT: APPAREIL DÉCORATIF À GAZ VENTILÉ; PAS UNE SOURCE DE CHALEUR; NE PAS UTILISER AVEC DU COMBUSTIBLE SOLIDE.**

THIS APPLIANCE NEEDS FRESH AIR FOR SAFE OPERATION AND MUST BE INSTALLED SO THERE ARE PROVISIONS FOR ADEQUATE COMBUSTION AND VENTILATION AIR. CET APPAREIL A BESOIN D'AIR FRAIS POUR UN FONCTIONNEMENT SÉCURISÉ ET DOIT ÊTRE INSTALLÉ POUR IL Y A DES DISPOSITIONS POUR UN AIR DE COMBUSTION ET DE VENTILATION ADEQUAT.

The installation, including provisions for combustion, ventilation air, and required minimum permanent vent opening, must conform with National Fuel Gas Code (ANSI Z223.1/NFPA 54) and applicable local building codes.  
L'installation, y compris les dispositions pour la combustion, l'air de ventilation et l'ouverture de ventilation permanente minimale requise, doit être conforme au National Fuel Gas Code (ANSI Z223.1 / NFPA 54) et aux codes du bâtiment locaux applicables.

**⚠ WARNING:** This gas appliance must not be connected to a chimney fuel servicing a solid fuel burning appliance.  
**⚠ AVERTISSEMENT:** Cet appareil à gaz ne doit pas être raccordé à un combustible de cheminée desservant un appareil à combustible solide.

**⚠ WARNING:** Improper installation, adjustment, alteration, service, or maintenance can cause property damage, personal injury, or loss of life. Refer to the owner's information manual provided with this appliance. Installation and service must be performed by a qualified installer, service agency, or the gas supplier.  
**⚠ AVERTISSEMENT:** Une installation, un réglage, une modification, un service ou un entretien inappropriés peuvent provoquer des dommages matériels, des blessures corporelles ou la mort. Reportez-vous au manuel d'information du propriétaire fourni avec cet appareil. L'installation et l'entretien doivent être effectués par un installateur qualifié, une agence de service ou le fournisseur de gaz.

**⚠ WARNING:** For installation in a solid-fuel burning fireplace only. The fireplace chimney must have a permanent vent opening to atmosphere of not less than 70 square inches, or as determined from the manufacturer's installation instructions.  
**⚠ AVERTISSEMENT:** Pour installation dans un foyer à combustible solide uniquement. La cheminée du foyer doit avoir une ouverture de ventilation permanente vers l'atmosphère d'au moins 70 pouces carrés, ou tel que déterminé à partir des instructions d'installation du fabricant.

**BATTERY-SIT**



3515 E. Atlanta Ave. Phoenix, AZ 85040  
07-00080

**DO NOT REMOVE THIS LABEL**

See installation & operating instructions for this model.  
Contact local building officials about restrictions and installation specifications in your area.

TESTED & LISTED BY:



ANSI Z21 60-2017  
CSA 2.26-2017  
Decorative gas appliances for installation in solid fuel burning fireplaces.

**C US**

REPORT # F29-187

	DATE OF MFG.	SERIAL #		
<b>MODEL: LAFV <input type="checkbox"/> VEN</b>	<b>18</b> <input type="checkbox"/>	<b>24</b> <input type="checkbox"/>	<b>30</b> <input type="checkbox"/>	<b>36</b> <input type="checkbox"/>
HIGH BTU/HR (kW):	45,000 (13.19kW)	56,000 (16.41kW)	75,000 (21.98kW)	86,000 (25.20kW)
LOW BTU/HR (kW):	30,000 (8.79kW)	35,000 (10.25kW)	45,000 (13.18kW)	55,000 (16.11kW)
<b>MODEL: LAFV <input type="checkbox"/> VEP</b>	<b>18</b> <input type="checkbox"/>	<b>24</b> <input type="checkbox"/>	<b>30</b> <input type="checkbox"/>	<b>36</b> <input type="checkbox"/>
HIGH BTU/HR (kW):	38,000 (11.14kW)	54,000 (15.83kW)	76,000 (22.27kW)	85,000 (24.91kW)
LOW BTU/HR (kW):	18,000 (5.27kW)	30,000 (8.79kW)	40,000 (11.72kW)	48,000 (14.05kW)

**NG Models**

Altitude  
Input  
Reduced Input  
P4  
Manifold Pressure: 3.5" w.c.(NG)  
Minimum Supply Pressure: 5" w.c.(NG)  
Maximum Supply Pressure: 10.5" w.c.(NG)  
Pression au Collecteur: .87wPA d'une colonne d'eau (GN)  
Pression d'Alimentation Min.: 1.25wPA d'une colonne d'eau (GN)  
Pression d'Alimentation Max.: 3.5wPA \*\* d'une colonne d'eau (GN) \*\*  
Maximum inlet pressure not to exceed 10.5".  
Minimum clearance to combustible materials: Top, sides & back.  
For non-combustible framing and finishing materials, see installation manual.

**MANIFOLD PRESSURE:**  
**ELECTRICAL RATING: 6V**  
**GAS TYPE: NATURAL GAS / LIQUID PROPANE**

**LP Models**

Elevation  
Alimentation / Alimentation Réduite  
P4  
Manifold Pressure: 10.5" w.c.(LP)  
Minimum Supply Pressure: 11" w.c.(LP)  
Max. Supply Pressure: 14" w.c.(LP)  
Pression au Collecteur: 2.40wPA d'une colonne d'eau (LP)  
Pression d'Alimentation Min.: 2.74wPA d'une colonne d'eau (LP)  
Pression d'Alimentation Max.: 3.5wPA \* d'une colonne d'eau (LP)  
\*\* Pression d'alimentation maximale ne devait pas dépasser 3.5wPA. Dégage ment minimum par rapport aux matériaux combustibles : Dessus, côtés et arrière : Pour les matériaux de charpente et de finition non combustibles, voir le manuel d'installation.

**⚠ WARNING VENTED DECORATIVE GAS APPLIANCE; NOT A SOURCE OF HEAT; NOT FOR USE WITH SOLID FUEL.**

**⚠ AVERTISSEMENT: APPAREIL DÉCORATIF À GAZ VENTILÉ; PAS UNE SOURCE DE CHALEUR; NE PAS UTILISER AVEC DU COMBUSTIBLE SOLIDE.**

THIS APPLIANCE NEEDS FRESH AIR FOR SAFE OPERATION AND MUST BE INSTALLED SO THERE ARE PROVISIONS FOR ADEQUATE COMBUSTION AND VENTILATION AIR. CET APPAREIL A BESOIN D'AIR FRAIS POUR UN FONCTIONNEMENT SÉCURISÉ ET DOIT ÊTRE INSTALLÉ POUR IL Y A DES DISPOSITIONS POUR UN AIR DE COMBUSTION ET DE VENTILATION ADEQUAT.

The installation, including provisions for combustion, ventilation air, and required minimum permanent vent opening, must conform with National Fuel Gas Code (ANSI Z223.1/NFPA 54) and applicable local building codes.  
L'installation, y compris les dispositions pour la combustion, l'air de ventilation et l'ouverture de ventilation permanente minimale requise, doit être conforme au National Fuel Gas Code (ANSI Z223.1 / NFPA 54) et aux codes du bâtiment locaux applicables.

**⚠ WARNING:** This gas appliance must not be connected to a chimney fuel servicing a solid fuel burning appliance.  
**⚠ AVERTISSEMENT:** Cet appareil à gaz ne doit pas être raccordé à un combustible de cheminée desservant un appareil à combustible solide.

**⚠ WARNING:** Improper installation, adjustment, alteration, service, or maintenance can cause property damage, personal injury, or loss of life. Refer to the owner's information manual provided with this appliance. Installation and service must be performed by a qualified installer, service agency, or the gas supplier.  
**⚠ AVERTISSEMENT:** Une installation, un réglage, une modification, un service ou un entretien inappropriés peuvent provoquer des dommages matériels, des blessures corporelles ou la mort. Reportez-vous au manuel d'information du propriétaire fourni avec cet appareil. L'installation et l'entretien doivent être effectués par un installateur qualifié, une agence de service ou le fournisseur de gaz.

**⚠ WARNING:** For installation in a solid-fuel burning fireplace only. The fireplace chimney must have a permanent vent opening to atmosphere of not less than 70 square inches, or as determined from the manufacturer's installation instructions.  
**⚠ AVERTISSEMENT:** Pour installation dans un foyer à combustible solide uniquement. La cheminée du foyer doit avoir une ouverture de ventilation permanente vers l'atmosphère d'au moins 70 pouces carrés, ou tel que déterminé à partir des instructions d'installation du fabricant.

## Damper Stop Installation

The damper must be permanently locked in position to prevent full closure and to provide a minimum flue opening. Various methods for locking the damper may be used but may be restricted from region to region and it is important to know the specifics that apply to your area. For your convenience a damper stop is provided with the appliance and may be used where not prohibited by state or local codes.

Use the 3" adjustable bolt to adjust the damper to the correct opening, based on the enclosed chart.

Should the damper stop not fit, or provide the required permanent opening from the minimum damper opening table, have the damper cut to provide a minimum permanent opening or install an alternate stop.

Creosote, ashes, and loose paint must be cleaned from the chimney flue and firebox by a qualified chimney cleaner, before installing in a solid fuel burning appliance. Any outside air ducts and/or ash dumps in the fireplace shall be permanently closed at time of appliance installation.

If the damper stop (supplied) is not applicable the damper may be fixed open by the following method:

- Drill a hole in either end of the damper
- Using a bolt of sufficient length and adjustment, with 2 nuts, secure to damper through the hole
- Adjust to correct opening

Appliance must be installed only in a solid-fuel burning fireplace with a working flue and constructed of non-combustible material.

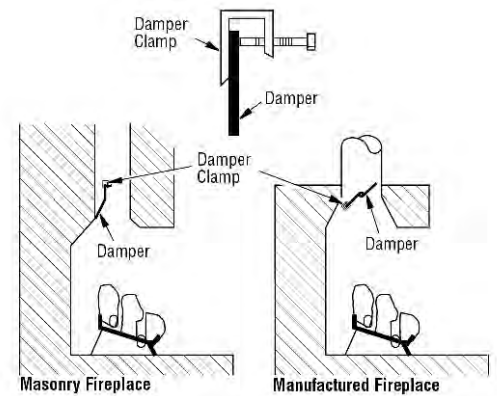

## Venting Requirements

Free opening area of chimney damper for venting combustion products (factory-built fireplaces)												
Chimney Height (ft)	Appliance Input Rate (kBtu/hr)											Maximum Input
	20	30	40	50	60	70	80	90	100	110	120	
	(Minimum opening in <sup>2</sup> )											
10	11.3	16.6	22.11	21.2	35.3	44.2	-	-	-	-	-	77.6
15	8.6	12.6	17.3	28.3	26.4	32.2	38.5	45.4	-	-	-	98.2
20	7.5	10.8	14.5	18.1	22.1	26.4	31.2	37.4	43	-	-	114.2
25	6.6	9.6	12.6	15.9	18.1	22.9	27.3	31.2	36.3	43	50.3	121
30	6.2	9.1	11.3	14.5	17.3	20.4	24.6	28.3	33.2	37.4	44.2	130.1
35	5.7	8	10.8	13.2	15.9	18.9	22.1	25.5	30.2	34.2	39.6	141.2
40	5.6	7.5	10.2	12.6	15.2	18.1	20.4	23.8	27.3	31.2	35.3	158.5

Height is from hearth to top of chimney and the minimum height is 10 feet. Chart shows some minimum opening (in<sup>2</sup>) for the given height and input rate.

Column marked "Maximum input" corresponds to the maximum allowable input rate (kBtu/hr) for the given height.

Free opening area of chimney damper for venting combustion products (masonry-built fireplaces)												
Chimney Height (ft)	Appliance Input Rate (kBtu/hr)											
	20	30	40	50	60	70	80	90	100	110	120	
	(Minimum opening in <sup>2</sup> )											
6	17.6	25.7	33.8	41.7	49.2	56.6	64	71.4	78.8	86.2	93.5	
8	16.5	23.7	31.2	38.7	45.5	52.4	59.7	66.9	74.1	81.3	88.6	
10	15.1	21.7	28.7	35.2	41.7	48.2	54.3	60.2	66.1	72	77.9	
15	14.1	19.9	26.1	32	37.7	43.2	48.8	54.1	59.4	64.6	69.9	
20	12.9	18.5	23.7	28.8	34.3	39.8	44.4	49.1	53.8	58.4	63	
30	12.2	16.9	21.6	26.5	31.2	35.9	40.3	44.5	48.6	52.7	56.6	

Height is from hearth to top of chimney and the minimum height is 6 feet.

Chart shows some minimum opening (in<sup>2</sup>) for the given height and input rate.

# GENERAL INSTRUCTIONS

MIN. FIRE BOX SIZE				
NG/LP	Front	Rear	Depth	Height
LAFV-18- (EN, VEN, EP, VEP)	28"	18"	16"	22"
LAFV-24- (EN, VEN, EP, VEP)	34"	24"	16"	22"
LAFV-30- (EN, VEN, EP, VEP)	40"	30"	18"	26"
LAFV-36- (EN, VEN, EP, VEP)	46"	36"	18"	26"

## LOG IDENTIFICATION

GFWOC18	18" Glowfire™ Arizona Weathered Oak Charred Logs
GFWOC24	24" Glowfire™ Arizona Weathered Oak Charred Logs
GFWOC30	30" Glowfire™ Arizona Weathered Oak Charred Logs
GFWOC36	36" Glowfire™ Arizona Weathered Oak Charred Logs
GFBRC18	18" Glowfire™ Aspen Birch Charred Log Set
GFBRC24	24" Glowfire™ Aspen Birch Charred Log Set
GFBRC30	30" Glowfire™ Aspen Birch Charred Log Set
GFBRC36	36" Glowfire™ Aspen Birch Charred Log Set

**LA** = Lava Burner

**FV** = Front View

**#** = Size

**E** = Electronic (Dexen ON/OFF)

**VE** =Variables Electronic (SIT Proflame 1)

**N** =Natural Gas

**P** = Propane

**BURNER SPECIFICATIONS**

**NATURAL GAS MODELS**

	<b>Rated</b>	<b>Rated</b>	<b>Rated Manifold</b>	<b>Rated Inlet</b>	<b>Rated Inlet</b>
NG Models	High	Low	Pressure	min	max
LAFV-18-EN	45,000	NA	3.5	5"	10.5"
LAFV-24-EN	56,000	NA	3.5	5"	10.5"
LAFV-30-EN	75,000	NA	3.5	5"	10.5"
LAFV-36-EN	86,000	NA	3.5	5"	10.5"

	<b>Rated</b>	<b>Rated</b>	<b>Rated Manifold</b>	<b>Rated Inlet</b>	<b>Rated Inlet</b>
NG Models	High	Low	Pressure	min	max
LAFV-18-VEN	45,000	30,000	3.5	5"	10.5"
LAFV-24-VEN	56,000	35,000	3.5	5"	10.5"
LAFV-30-VEN	75,000	45,000	3.5	5"	10.5"
LAFV-36-VEN	86,000	55,000	3.5	5"	10.5"

**LIQUID PROPANE MODELS**

	<b>Rated</b>	<b>Rated</b>	<b>Rated Manifold</b>	<b>Rated Inlet</b>	<b>Rated Inlet</b>
LP Models	High	Low	Pressure	min	max
LAFV-18-EP	38,000	NA	10.5	11"	14"
LAFV-24-EP	54,000	NA	10.5	11"	14"
LAFV-30-EP	76,000	NA	10.5	11"	14"
LAFV-36-EP	85,000	NA	10.5	11"	14"

	<b>Rated</b>	<b>Rated</b>	<b>Rated Manifold</b>	<b>Rated Inlet</b>	<b>Rated Inlet</b>
LP Models	High	Low	Pressure	min	max
LAFV-18-VEP	38,000	18,000	10.5	11"	14"
LAFV-24-VEP	54,000	30,000	10.5	11"	14"
LAFV-30-VEP	76,000	40,000	10.5	11"	14"
LAFV-36-VEP	85,000	48,000	10.5	11"	14"

# PARTS LIST

## VEN & VEP MODELS

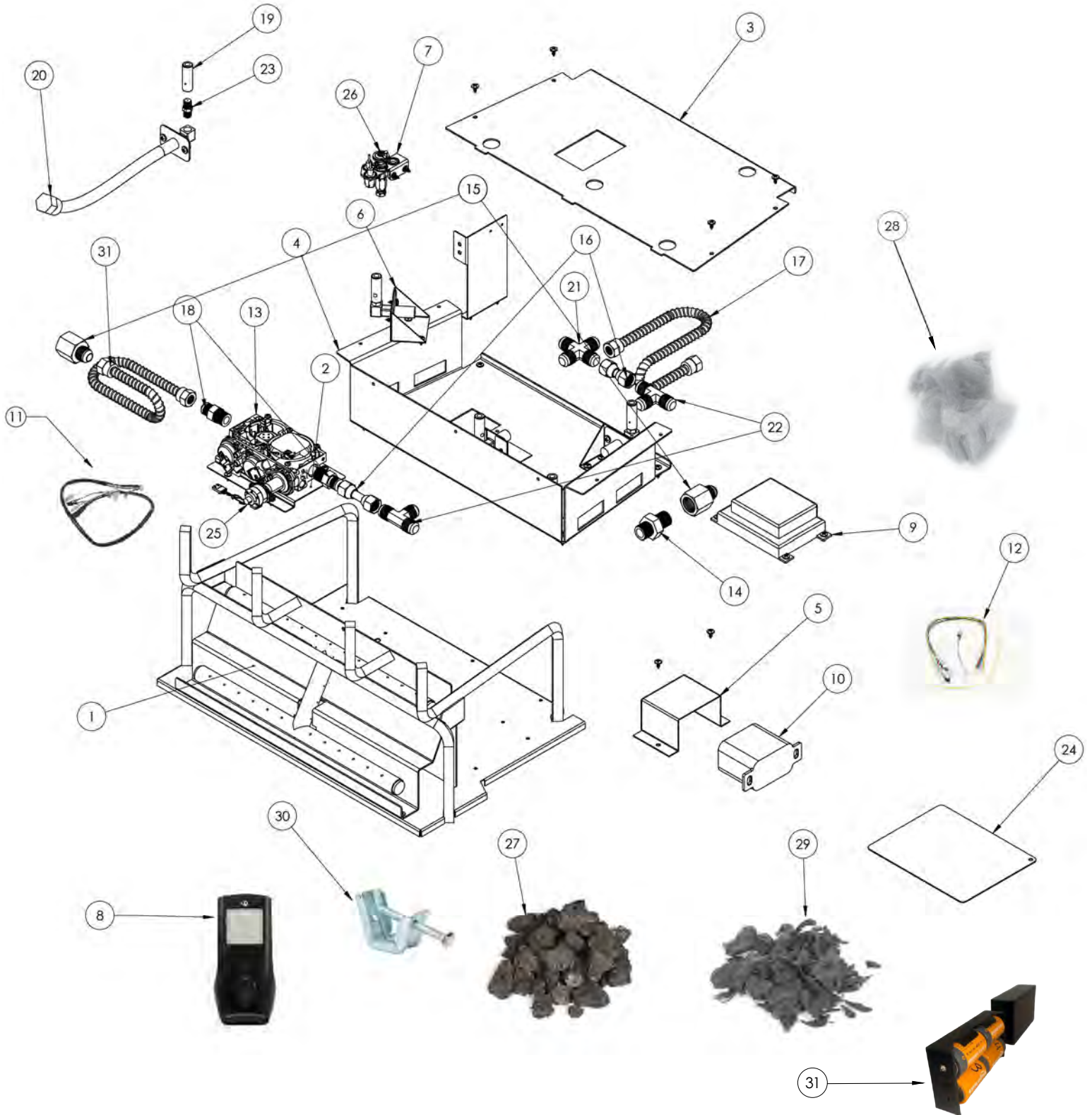

## VEN & VEP MODELS

LAFV-XX-VEN   LAFV-XX-VEP							
ITEM NO.	PART NO.	DESCRIPTION	QTY:	18	24	30	36
1	02-00721-XX	LAVA BURNER FRONT VIEW COMPLETE ASSEMBLY	1	-			
2	02-00730	SHEET METAL, BRACKET, CLEARANCE VALVE STAND	1	-			
3	02-00731-XX	SHEET METAL, PLATE MEDIA DECK, LOG INDEX	1	-			
4	02-00726-XX	SHEET METAL, RECESSED DROP IN TRAY, REMOVABLE HOUSING	1	-			
5	02-00752	SHEET METAL, HOLDER, BRACKET	1	-			
6	02-00753	SHEET METAL, BRACKET, BULKHEAD SUPPORT	1	-			
7	0.199.049	ASSEMBLED IGNITION PILOT-NG	1	-			
8	0.584.042	PROFLAME TX TMFL-BLACK	1	-			
9	0.584.622	IPI IGNITION BOARD 5SEC FFRT	1	-			
10	0.584.523	PROFLAME RECEIVER KIT (ON/OFF, REMOTE)	1	-			
11	0.584.906	WIRE HARNESS WITH CONNECTOR FOR AC/DC POWER ADAPTOR	1	-			
12	0.584.912	WIRE HARNESS AND PILOT GROUND WIRE+ CPI/IPI SWITCH	1	-			
13	0.885.006	PROFLAME VALVE STEPPER NG 3.5"-1.6"W.C._2021	1	-			
14	AM8-XX	AIR MIXER, 1/2 MIP X 1/2 MIP BLANK	1	-			
15	46-88	1/2 OD X 1/2 FIP FEMALE CONNECTOR	2	-			
16	US-4-8	1/2" X 1/2" SWIVEL NUT UNION	-	2	2	1	1
17	200-9898-6	6" STAINLESS STEEL FLEX LINE	1	2	3	4	2
	200-9898-10	10" STAINLESS STEEL WHISTLE FREE FLEX LINE	1	-	-	-	1
18	48-88	1/2" X 1/2" STRAIGHT CONNECTOR	2	-			
19	02-00751	1/8-27 FIP X 3.5" LENGTH ROUND TUBE STOCK	4	-			
20	200MB-2	12" FLEX/ORIFICE GAS CONNECTOR BULK HEAD 1/2 OD FLEX LINE	4	-			
21	C-1-8	1/2" BRASS FLARE CROSS	1	-			
22	44-8	44 SERIES TEE 1/2"	2	-			
23	306-2-GC70	306 - 1/8" DRILLED TO #70	4	-			
24	02-00214	SHEET METAL, 5.5 X 6.75, RATING PLATE	1	-			
27	HP-B-R-10	10 LBS. LAVA ROCK	1	1	1	2	2
28	PBE-1	1 GRAM, PLATINUM EMBERS	1	1	1	1	1
29	GLE-10	6 OZ, BLACK EMBERS	1	1	1	2	2
30	00F0545	DAMPER CLAMP	1	1	1	1	1
31	01-00343	BATTERY PACK	1	-			
	13-00182	HEAT SHIELD	1	-			
LP CONVERSION KIT							
25	0.907.015	C.K. STEP-M LPG 11-2.9" W.C.	1	VEP MODELS			
26	0.977.167	LP PILOT ORIFICE	1				

# PARTS LIST

## EN & EP MODELS

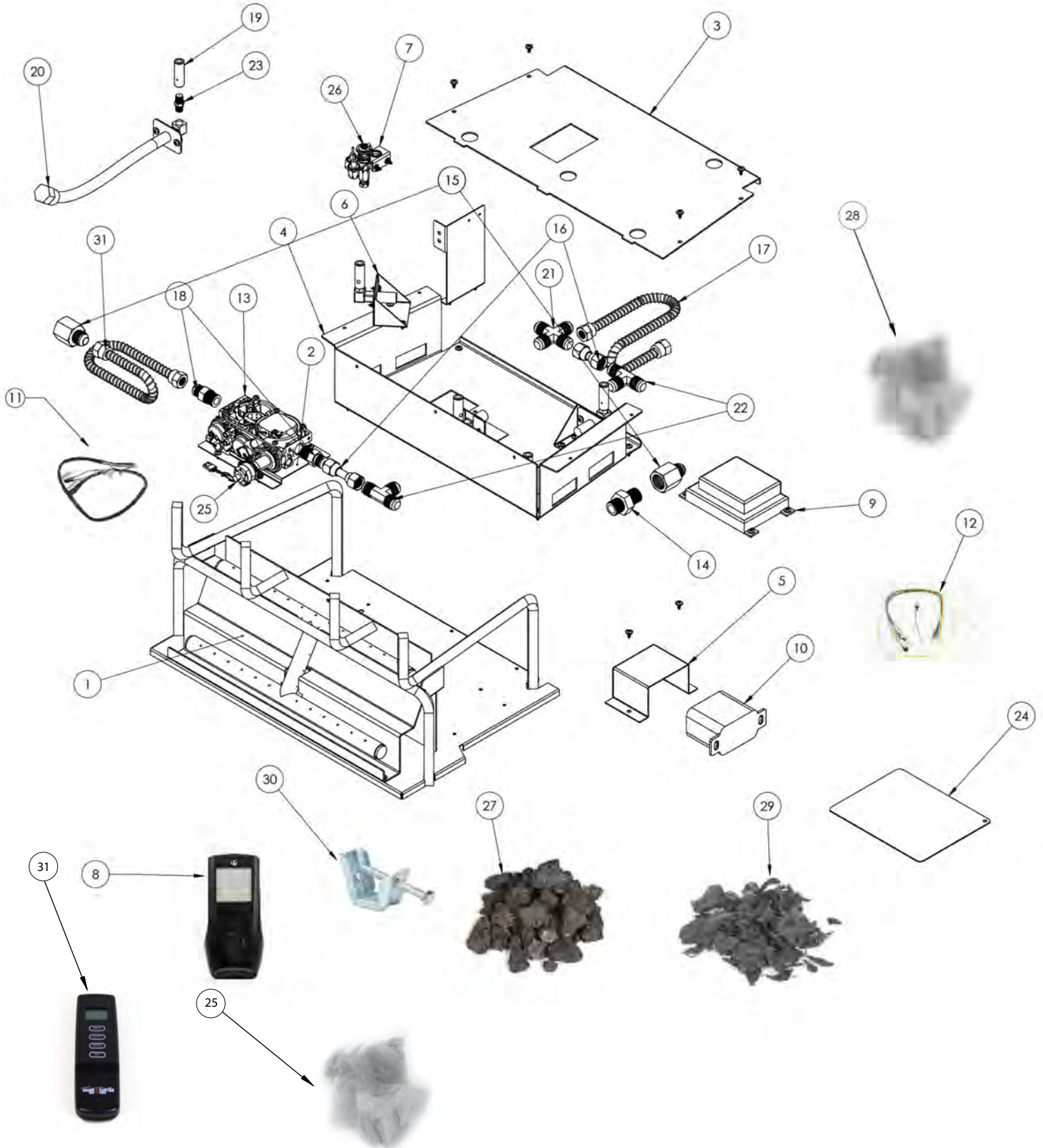

EN & EP MODELS

LAFV-XX-EN   LAFV-XX-EP								
ITEM NO.	PART NO.	DESCRIPTION	QTY:	18	24	30	36	
1	02-00721-XX	LAVA BURNER FRONT VIEW COMPLETE ASSEMBLY	1	-				
2	02-00730	SHEET METAL, BRACKET, CLEARANCE VALVE STAND	1	-				
3	02-00731-XX	SHEET METAL, PLATE MEDIA DECK, LOG INDEX	1	-				
4	02-00726-XX	SHEET METAL, RECESSED DROP IN TRAY, REMOVABLE HOUSING	1	-				
5	02-00752	SHEET METAL, HOLDER, BRACKET	1	-				
6	02-00753	SHEET METAL, BRACKET, BULKHEAD SUPPORT	1	-				
7	3V-BAT	3V DEXEN BATTERY PACK (2 D-CELL BATTERIES NOT INCLUDED)	1	-				
8	3V-PIL-24	24" NATURAL GAS 3V PILOT ASSEMBLY	1	-				
9	6003V	60003-NAT 3.5" W.C 3/8 X 3/8 STRAIGHT THRU: W/1/4" PILOT FITTING	1	-				
10	6K-WIR	GM6K TO 6003V WIRE HARNESS (12" VAL WIR, 84" SWITCH, BAT WIR)	1	-				
11	GM6KA	6K MODULE FOR 3V IGN MODULE	1	-				
12	GAS-GCRK	GRAND CANYON REMOTE KIT	1	-				
13	AM8-XX	AIR MIXER, 1/2 MIP X 1/2 MIP BLANK	1	-				
14	46-88	FITTING, ADAPTER, 1/2 FLARE X 1/2 FIP	2	-				
15	US-4-8	1/2" X 1/2" SWIVEL NUT UNION	-	2	2	1	1	
16	200-9898-6	6" STAINLESS STEEL FLEX LINE	-	2	3	4	2	
	200-9898-10	10" STAINLESS STEEL WHISTLE FREE FLEX LINE	-	-	-	-	1	
17	48-88	1/2" X 1/2" STRAIGHT CONNECTOR	2	-				
18	02-00751	1/8-27 FIP X 3.5" LENGTH ROUND TUBE STOCK	4	-				
19	200MB-2	12" FLEX/ORIFICE GAS CONNECTOR BULK HEAD 1/2 OD FLEX LINE	4	-				
20	C-1-8	1/2" BRASS FLARE CROSS	1	-				
21	44-8	44 SERIES TEE 1/2"	2	-				
22	306-2-GC70	306 - 1/8" DRILLED TO #70	4	-				
23	02-00214	SHEET METAL, 5.5 X 6.75, RATING PLATE	1	-				
24	HP-B-R-10	10 LBS. LAVA ROCK	1	1	1	2	2	
25	PBE-1	1 GRAM, PLATINUM EMBERS	1	1	1	1	1	
26	GLE-10	6 OZ, BLACK EMBERS	1	1	1	2	2	
27	00F0545	DAMPER CLAMP	1	1	1	1	1	
28	T202-9898-16	BLACK COATED, WHISTLE FREE FLEX LINE, 1/2" X 16"	1	1	1	1	1	
31	GCRK	Grand Canyon Remote Kit	1	-				
LP CONVERSION KIT							EP MODELS	
29	LP-PIL	3V DEXEN PROPANE PILOT ORIFICE	1					
30	LP-VAL	LP PRESSURE REGULATOR FOR 6003V VALVE 10" W.C	1					

### Before you begin

Thank you for purchasing Grand Canyon Gas Log's **Lava Burner Front View with Glowfire™ Logs**. This product has been designed to provide you with safe, trouble-free operation.

Please read this manual thoroughly before beginning the installation. It has information which is important for safe installation and operation.

Please inspect your shipment for completeness and any damage. Contact your retailer if any damage is found. Do not install your appliance with any damage or substituted parts.

The installation of your **Lava Burner Front View with Glowfire™ Logs** will follow the steps listed:

- Pre-Installation planning - ensure the opening of the fireplace meets the specification
- Electric installation - Install batteries per page 28 and/or page 34
- Gas installation (Preferred right side)
- Installing the burner
- Media and log placement

Before you begin the installation you should have the following tools and supplies:

- Pipe wrenches
- Safety glasses and gloves
- Approved pipe joint sealant
- Manometer
- Leak detection fluid (non-corrosive) or electronic gas detector
- Appropriate gas supply line parts

# WIRING DIAGRAM INSTALLATION

## Dexen 6003V (EN/EP) Control System

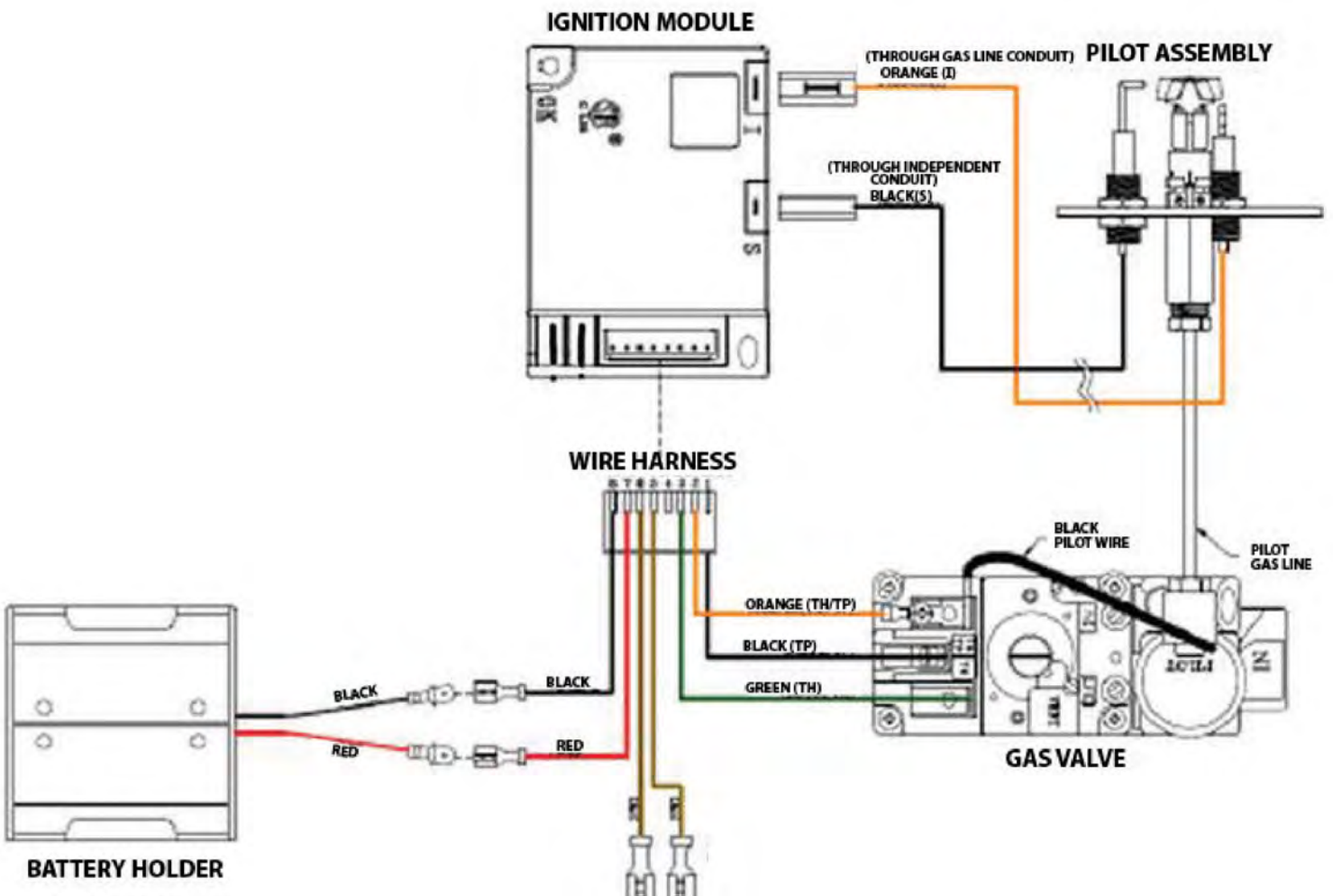

# WIRING DIAGRAM

## SIT Proflame 1 (VEN/VEP) Control System

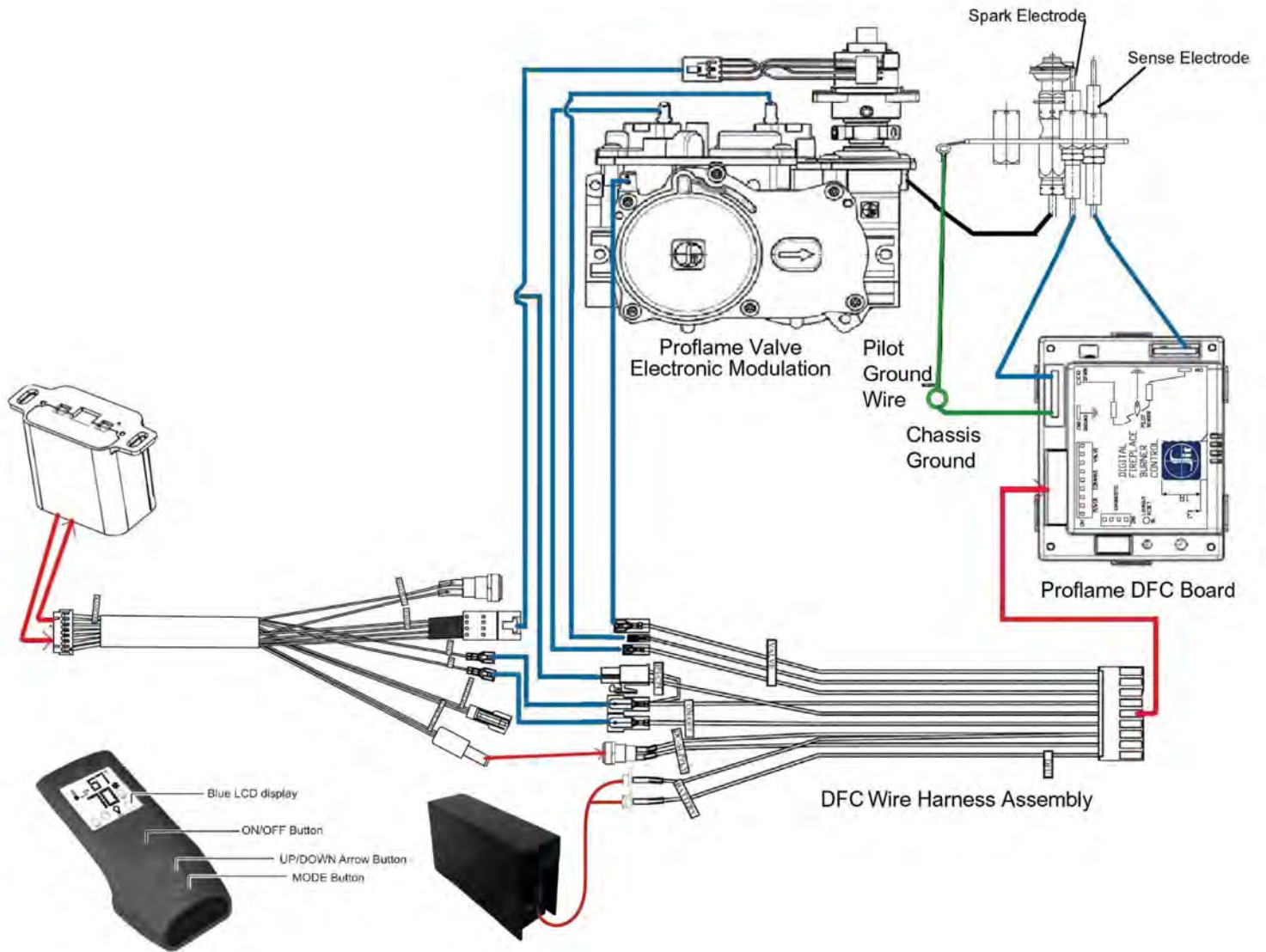

Installation must include an equipment shutoff valve, union and plugged 1/8" NPT tap. Locate NPT tap within reach for test gauge hook up. NPT tap must be upstream from appliance.

**IMPORTANT:** Install equipment shutoff valve in an accessible location. The equipment shutoff valve is for turning on or shutting off the gas to the appliance.

Check your building codes for any special requirements for locating equipment shutoff valve to appliances.

Apply pipe joint sealant lightly to male NPT threads. This will prevent excess sealant from going into pipe. Excess sealant in pipe could result in clogged appliance valves.

## CONNECTING TO GAS SUPPLY

**⚠ WARNING:** This appliance requires a 1/2" NPT (National Pipe Thread) inlet connection to the pressure regulator.

**⚠ WARNING:** A qualified service person must connect appliance to gas supply. Follow all local codes.

**⚠ WARNING:** *Never connect this appliance to private (non-utility) gas wells. This gas is commonly known as wellhead gas and does not have odorants and may have impurities, and variations in BTU content. The use of well-head gas will void the manufacturer's warranty to this appliance.*

When an appliance is for connection to a fixed piping system, the installation must conform with local codes, or in the absence of local codes with the National Fuel Gas Code, ANSI Z223.1 • NFPA 54; National Fuel Gas Code.

**⚠ CAUTION:** Use only new, black iron or steel pipe. Internally-tinned copper tubing may be used in certain areas. Check your local codes. Use pipe of 1/2" diameter or greater to allow proper gas volume to appliance. If pipe is too small, undue loss of volume will occur.

## Installation Items Needed

Before installing appliance, make sure you have the items listed below.

- External regulator (supplied by installer)
- Piping (check local codes)
- Sealant (resistant to propane/LP gas)
- Equipment shutoff valve \*
- Test gauge connection \*
- Sediment trap
- Tee joint
- Pipe wrench
- Approved flexible gas line with gas connector (if allowed by local codes) (not provided)

\* An equipment shutoff valve with 1/8" NPT tap is an acceptable alternative to test gauge connection. Purchase the optional equipment shutoff valve from your dealer.

For propane/LP units, the installer must supply an external regulator. The external regulator will reduce incoming gas pressure. You must reduce incoming gas pressure to between 11" and 14" of water. If you do not reduce incoming gas pressure, appliance regulator damage could occur. Install external regulator with the vent pointing down as shown in Figure B. Pointing the vent down protects it from freezing rain or sleet.

**⚠ CAUTION:** Use only new, black iron or steel pipe. Internally-tinned copper tubing may be used in certain areas. Check your local codes. Use pipe of 1/2" diameter or greater to allow proper gas volume to appliance. If pipe is too small, undue loss of volume will occur.

Installation must include an equipment shutoff valve, union and plugged 1/8" NPT tap. Locate NPT tap within reach for test gauge hook up. NPT tap must be upstream from appliance (see Figure C). **IMPORTANT:** Install equipment shutoff valve in an accessible location. The equipment shutoff valve is for turning on or shutting off the gas to the appliance.

Check your building codes for any special requirements for locating equipment shutoff valve to appliances.

Apply pipe joint sealant lightly to male NPT threads. This will prevent excess sealant from going into pipe. Excess sealant in pipe could result in clogged appliance valves.

**⚠ WARNING:** Use pipe joint sealant that is resistant to liquid petroleum (LP) gas.

## PRE-INSTALLATION

We recommend that you install a sediment trap in supply line as shown in Figure C. Locate sediment trap where it is within reach for cleaning.

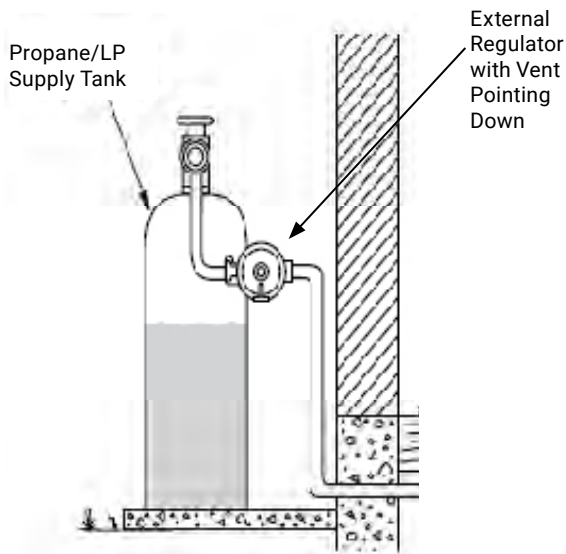

**Figure B - External Regulator with Vent Pointing Down**

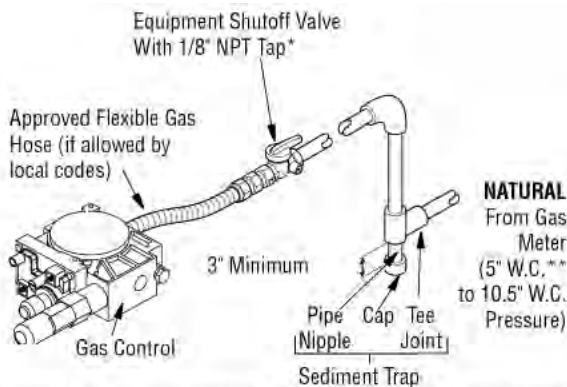

- \* Purchase the optional equipment shutoff valve from your dealer.
- \*\* Minimum inlet pressure for purpose of input adjustment.

**Figure C - Gas Connection**

**⚠ CAUTION: Avoid damage to gas control. Hold gas control with wrench when connecting it to gas piping and/or fittings.**

## CHECKING GAS CONNECTIONS

**⚠ WARNING: Test all gas piping and connections, internal and external to unit, for leaks after installing or servicing. Correct all leaks at once.**

**⚠ WARNING: Never use an open flame to check for a leak. Apply a noncorrosive leak detection fluid to all joints. Bubbles forming show a leak. Correct all leaks at once.**

**⚠ CAUTION: Make sure external regulator has been installed between propane/LP supply and appliance. See guidelines under Connecting to Gas Supply.**

## PRESSURE TESTING GAS SUPPLY PIPING SYSTEM

The appliance and its appliance main gas valve must be disconnected from the gas supply piping system during any pressure testing of that system at test pressures **in excess of 1/2 psi (3.5 kPa)**. The appliance must be isolated from the gas supply piping system by closing its equipment shutoff valve during any pressure testing of the gas supply piping system at test pressures **equal to or less than 1/2 psi (3.5 kPa)**.

### Test Pressures In Excess Of 1/2 PSIG (3.5 kPa)

1. Disconnect appliance with its appliance main gas valve (control valve) and equipment shutoff valve from gas supply piping system. Pressures in excess of 1/2 PSIG will damage appliance regulator.
2. Cap off open end of gas pipe where equipment shutoff valve was connected.
3. Pressurize supply piping system by opening main gas valve located on or near gas meter for natural gas or using compressed air.
4. Check all joints of gas supply piping system. Apply noncorrosive leak detection fluid to all joints. Bubbles forming show a leak.
5. Correct all leaks at once.
6. Reconnect appliance and equipment shutoff valve to gas supply. Check reconnected fittings for leaks.

### Test Pressures Equal To or Less Than 1/2 PSIG (3.5 kPa)

1. Close equipment shutoff valve (see next page).
2. Pressurize supply piping system by either opening propane/LP supply tank valve for propane/LP gas or opening main gas valve located on or near gas meter for natural gas or using compressed air.
3. Check all joints from gas meter to equipment shutoff valve for natural gas or propane/LP supply to equipment shutoff valve for propane/LP. Apply noncorrosive leak detection fluid to all joints. Bubbles forming show a leak.

## PRESSURE TESTING APPLIANCE GAS CONNECTIONS

1. Open equipment shutoff valve.
2. Open main gas valve located on or near gas meter for natural gas.
3. Make sure control knob of appliance is in the OFF position.
4. Check all joints from gas meter to equipment shutoff valve for natural gas. Apply noncorrosive leak detection fluid to all joints. Bubbles forming show a leak.
5. Correct all leaks at once.
6. Light appliance. Check all other internal joints for leaks.
7. Turn off appliance.

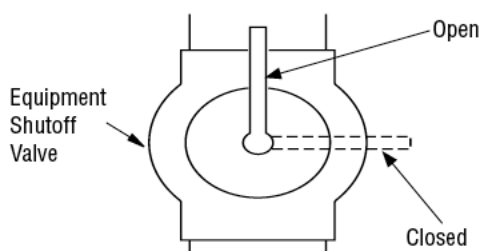

**Equipment Shutoff Valve**

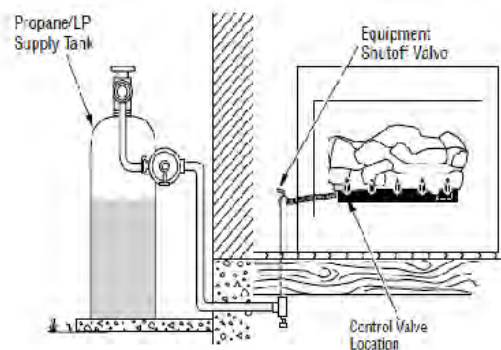

**Checking Gas Joints (Natural Gas Only)**

We recommend that you install a sediment trap in supply line as shown in **Figure C**. Locate sediment trap where it is within reach for cleaning.

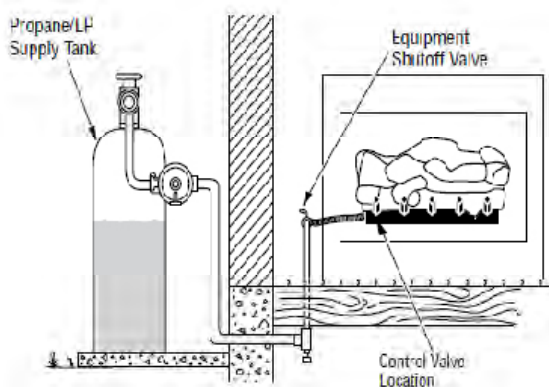

**External Regulator with Vent Pointing Down**

**For Massachusetts Residents Only:** Installation of this gas log set as a vented indoor appliance in the Commonwealth of Massachusetts requires the damper be permanently removed or welded in the fully open position.

You must install the damper clamp accessory. This will ensure vented operation. The damper clamp will keep damper open.

For minimum permanent flue opening you must provide. Attach damper clamp so the minimum permanent flue opening will be maintained at all times

### INSTALLING APPLIANCE BASE ASSEMBLY

Clear fireplace of all debris. Center burner inside the fireplace left to right and push burner in the back as far back in the fireplace as possible.

# INSTALLATION STEPS



Figure 1



Figure 2



Figure 3



Figure 4



Figure 7



Figure 8

The Grand Canyon Gas Logs burner system must be installed by a qualified professional service technician. Instructions must be followed carefully to ensure proper performance and full benefit from the burner system. Check to be sure the burner system is designed and labeled for the type of gas (natural or propane gas) supplied to the fireplace. Fireplace floor must be level, clean, and smooth.

**WARNING: Failure to position the parts in accordance with these diagrams or failure to use only parts specifically approved with this appliance may result in property damage or personal injury.**

1. MAKE SURE THE FIREPLACE GAS SUPPLY IS TURNED OFF.

2. Locate the gas-supply stub inside the fireplace (Figure 1) and remove the cap, if attached.

**CAUTION:** When removing the cap, make sure the stub does not turn, loosening the connection inside the wall.

3. Place the burner system in the fireplace (Figure 2). Center the burner from left to right in the fireplace.

4. **Be sure gas to the fireplace is off.** Remove the adapter (46-88) connected to the flex connector (T202-9898-16) located in the accessory box. Attach the adapter to the gas-supply stub using a pipe compound resistant to all gases. Tighten securely. Then attach the open end of the flex connector to the adapter (Figure 3). Tighten securely. Then attach flex connector to burner valve (Figure 4) assembly located on the left-hand side of the burner. Tighten securely.

5. **LEAK TEST:** Turn on the fireplace gas supply, and test at all connections for leaks using the appropriate soapy water solution. If bubbles appear, a leak is present. Turn off the gas and tighten at all connections. Repeat until no leaks are present. If a leak persists, turn off the gas supply and contact the local gas company or dealer. **NEVER USE A FLAME TO CHECK FOR LEAKS.**

6. Next, install the batteries into the receiver. Refer to the Battery Installation page for battery installation instructions. Ensure the receiver is placed back into the heat shield located on the bottom right-hand side of the burner plate after the batteries have been installed.

7. Locate the 6V D-cell battery connector wiring harness on the back side of the burner assembly and connect it to the D-cell battery pack. (Figure 5 and 6).



Figure 5



Figure 6

8. Place the connected 6V D-cell battery pack on the right side of the burner inside the fireplace. (Figure 7 and 8).

## LIGHTING TEST

Prior to proceeding with installation, perform a lighting test (see lighting instructions for lighting your burner). Allow the unit to completely cool after testing.

## IMPORTANT

For all valves, the air **MUST** be purged from the gas line before the pilot will light and burn properly. The time needed to purge will depend on the length of the gas line to the unit and the amount of time since the unit or gas line was last used. It may take several minutes before all the air is purged and the pilot will light and burn properly. Reference the **LIGHTING INSTRUCTIONS** section in this manual.

# INSTALLATION STEPS

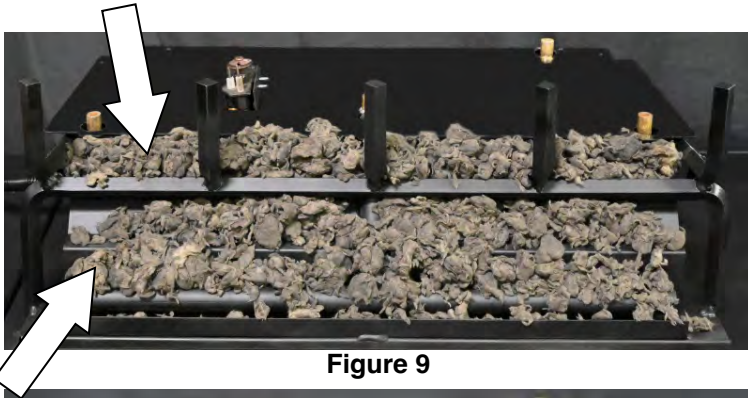

The Grand Canyon Gas Logs burner system must be installed by a qualified professional service technician. Instructions must be followed carefully to ensure proper performance and full benefit from the burner system. Check to be sure the burner system is designed and labeled for the type of gas (natural or propane gas) supplied to the fireplace. Fireplace floor must be level, clean, and smooth.

**WARNING:** Failure to position the parts in accordance with these diagrams or failure to use only parts specifically approved with this appliance may result in property damage or personal injury.

1. MAKE SURE THE FIREPLACE GAS SUPPLY IS TURNED OFF.
2. Locate the gas-supply stub inside the fireplace (Figure 9) and remove the cap, if attached.

**CAUTION:** When removing the cap, make sure the stub does not turn, loosening the connection inside the wall.

3. Place the burner system in the fireplace (Figure 10). Center the burner from left to right in the fireplace.
4. **Be sure gas to the fireplace is off.** Remove the adapter (46-88) connected to the flex connector (T202-9898-16) located in the accessory box. Attach the adapter to the gas-supply stub using a pipe compound resistant to all gasses. Tighten securely. Then attach the open end of the flex connector to the adapter (Figure 11). Tighten securely. Then attach flex connector to burner valve (Figure 12) assembly located on the left-hand side of the burner. Tighten securely.

5. **LEAK TEST:** Turn on the fireplace gas supply, and test at all connections for leaks using the appropriate soapy water solution. If bubbles appear, a leak is present. Turn off the gas and tighten at all connections. Repeat until no leaks are present. If a leak persists, turn off the gas supply and contact the local gas company or dealer. **NEVER USE A FLAME TO CHECK FOR LEAKS.**

6. Next the batteries can be installed for the specific burner system. Refer to Battery Installation page for inserting the batteries. Ensure battery pack and receiver are placed back in the heat shield located on the bottom right-hand side of the pan.
7. Install the battery pack right side of the burner inside the fireplace. (Figure 5 and 6).

# LOG PLACEMENT

## Firelog Installation Warnings

1. **Firelogs are fragile.** Handle them gently to prevent damage to their paint or the fireplace.
2. **Arrange firelogs as shown the log section.** Do not arrange them in any other way. If firelogs are not installed per installation instructions, flame impingement and improper combustion may occur and result in soot and/or excessive production of carbon monoxide (CO). Carbon monoxide is a toxic, colorless, and odorless gas.
3. **Do not install the firelog media until** fireplace installation is complete, the gas line is connected and tested for leaks, and initial burner operation has been inspected and approved.
4. **Keep 1 inch around the pilot (behind pilot hood) completely clear of any media or debris.** Contact between the nickel strands and the spark plug cable may lead to failure operating the fireplace.
5. **Do not cover over the main burner holes** unless otherwise stated in this manual. Blocking the holes can cause a gas release that could cause an explosion in the fireplace.

**NOTE:** It can take up to 20 minutes for the flames to turn yellow.

## Nickel Strands

Use your fingers to separate the nickel strands as shown in the image below. It is recommended to remove the strips to make it easier to separate them.



**Before**

**After**

**Left:** Nickel strands as supplied | **Right:** Nickel stands ready to use.

## 18" GLOWFIRE™ ARIZONA WEATHERED OAK CHARRED LOGS PLACEMENT GUIDE

Part #	Description
GFWOC18	18" Glowfire™ Arizona Weathered Oak Charred Log Set
05-00129	18" Left Front Log
05-00130	18" Right Front Log
05-00131	18" Back Log
05-00151	Static Log #2
05-00152	Static Log #1
05-00153	Static Log #3
05-00154	Static Log #4
05-00156	18"/24" Middle Log

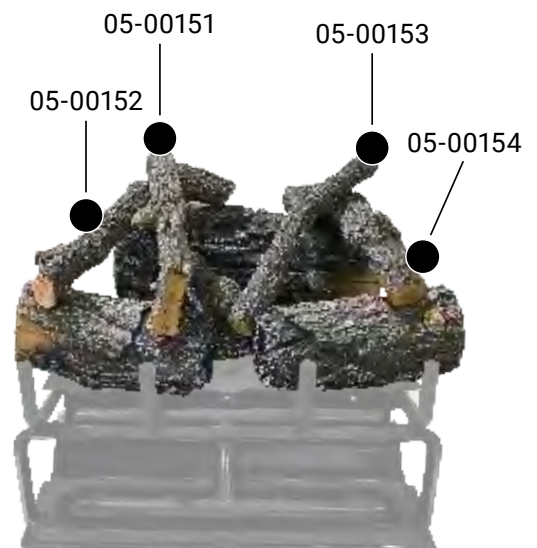
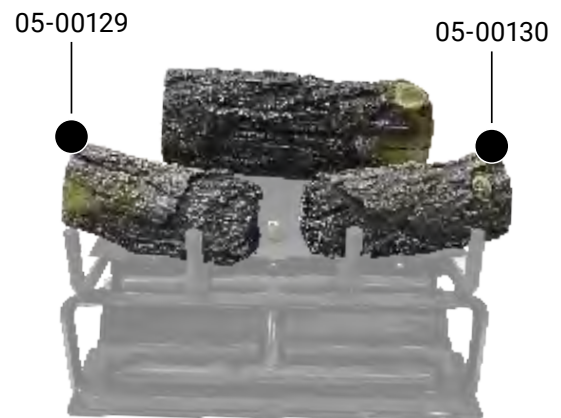

# LOG PLACEMENT

## 24" GLOWFIRE™ ARIZONA WEATHERED OAK CHARRED LOGS PLACEMENT GUIDE

Part #	Description
GFWOC24	24" Glowfire™ Arizona Weathered Oak Charred Log Set
05-00131	24" Back Log
05-00132	24" Left Front Log
05-00133	24" Right Front Log
05-00153	24" Static Log #1
05-00154	24" Static Log #3
05-00155	24" Static Log #4
05-00156	18"/24" Middle Log
05-00159	24" Static Log #2

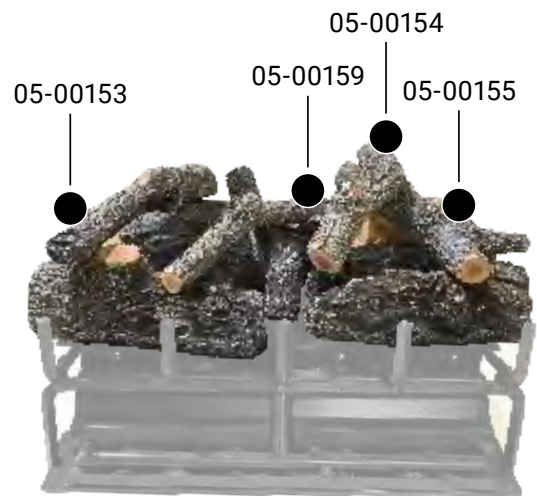
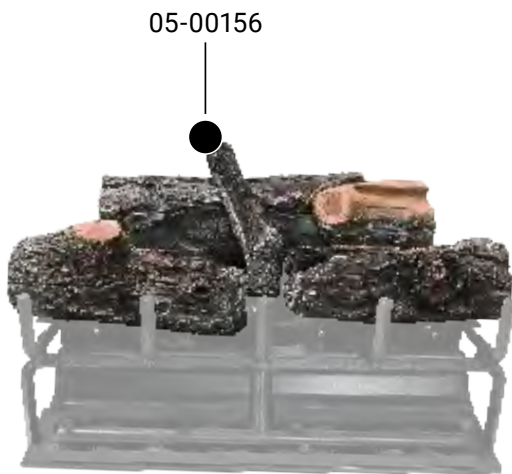
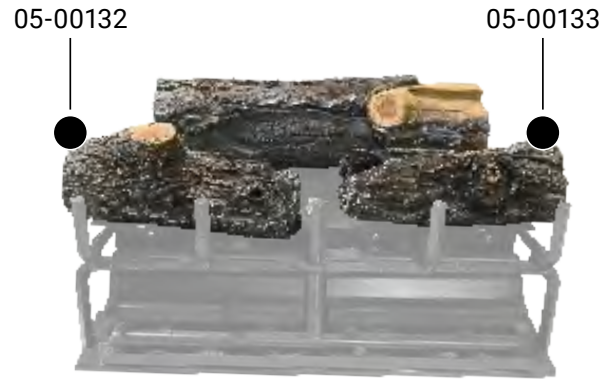
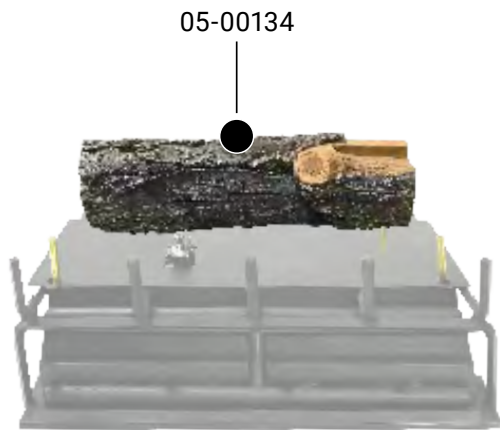

## 30" GLOWFIRE™ ARIZONA WEATHERED OAK CHARRED LOGS PLACEMENT GUIDE

Part #	Description
GFWOC30	30" Glowfire™ Arizona Weathered Oak Charred Log Set
05-00135	30" Left Front Log
05-00136	30" Right Front Log
05-00137	30" Back Log
05-00150	30" Static Log #6
05-00153	30" Static Log #5
05-00157	30"/36" Middle Log
05-00158	30" Static Log #3
05-00159	30" Static Log #2
05-00160	30" Static Log #1
05-00161	30" Static Log #4

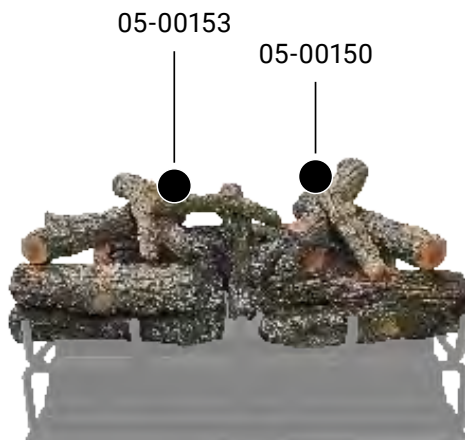
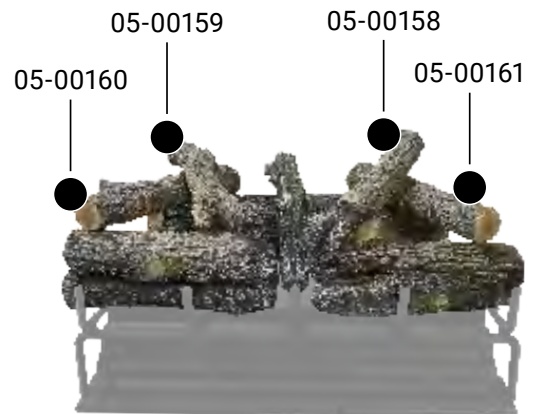
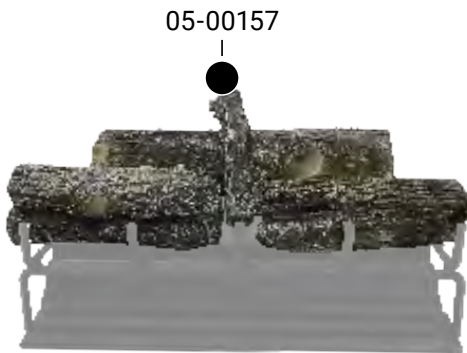
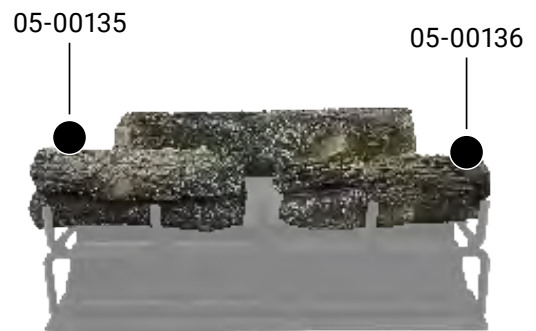
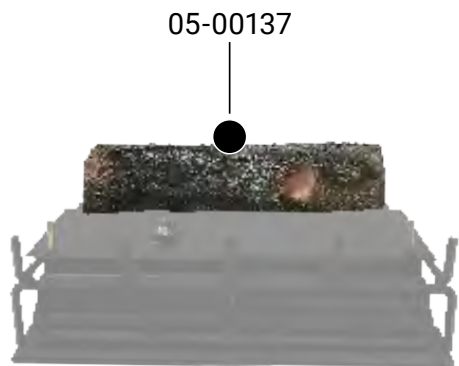

# LOG PLACEMENT

## 36" GLOWFIRE™ ARIZONA WEATHERED OAK CHARRED LOGS PLACEMENT GUIDE

Part #	Description
GFWOC36	36" Glowfire™ Arizona Weathered Oak Charred Log Set
05-00138	36" Left Front Log
05-00139	36" Right Front Log
05-00140	36" Back Log
05-00150	36" Static Log #6
05-00153	36" Static Log #5
05-00157	30"/36" Middle Log
05-00158	36" Static Log #3
05-00159	36" Static Log #2
05-00160	36" Static Log #1
05-00161	36" Static Log 4

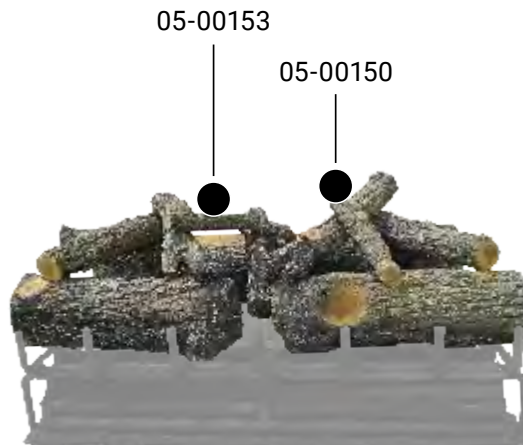
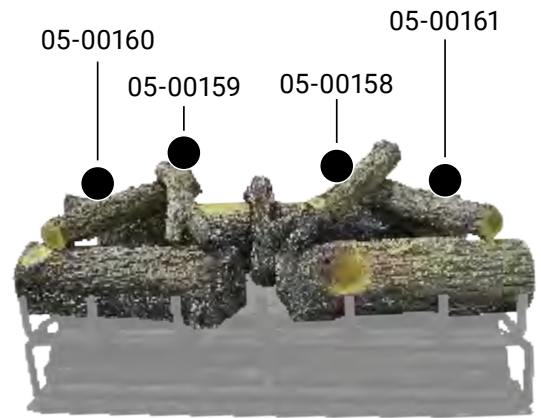
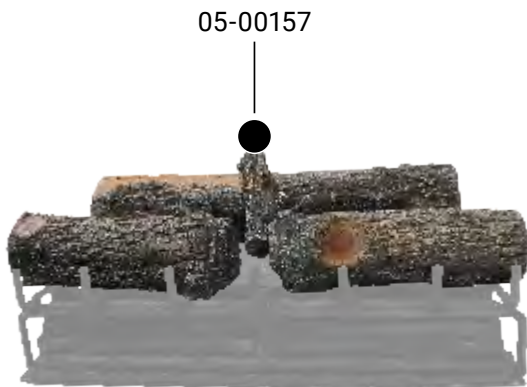
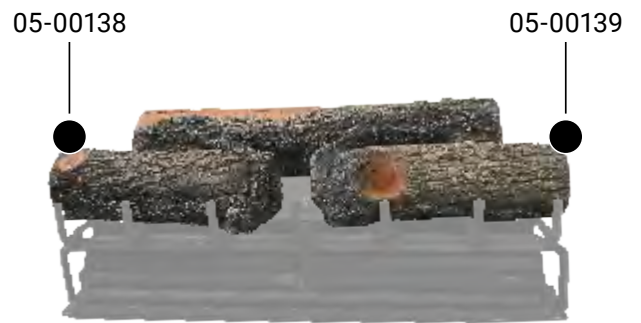
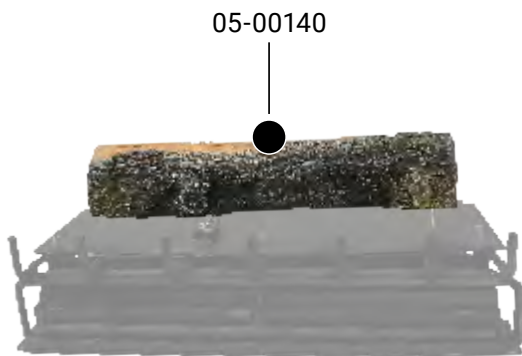

## 18" GLOWFIRE® ASPEN BIRCH CHARRED LOG PLACEMENT GUIDE

Part #	Description
GFBRC18	18" Glowfire™ Aspen Birch Charred Log Set
05-00190	18" Front Left
05-00191	18" Front Right
05-00192	18" Back Log
05-00193	18" Middle Log
05-00194	18" Static Log #1
05-00195	18" Static Log #3
05-00196	18" Static Log #2
05-00197	18" Static Log #4

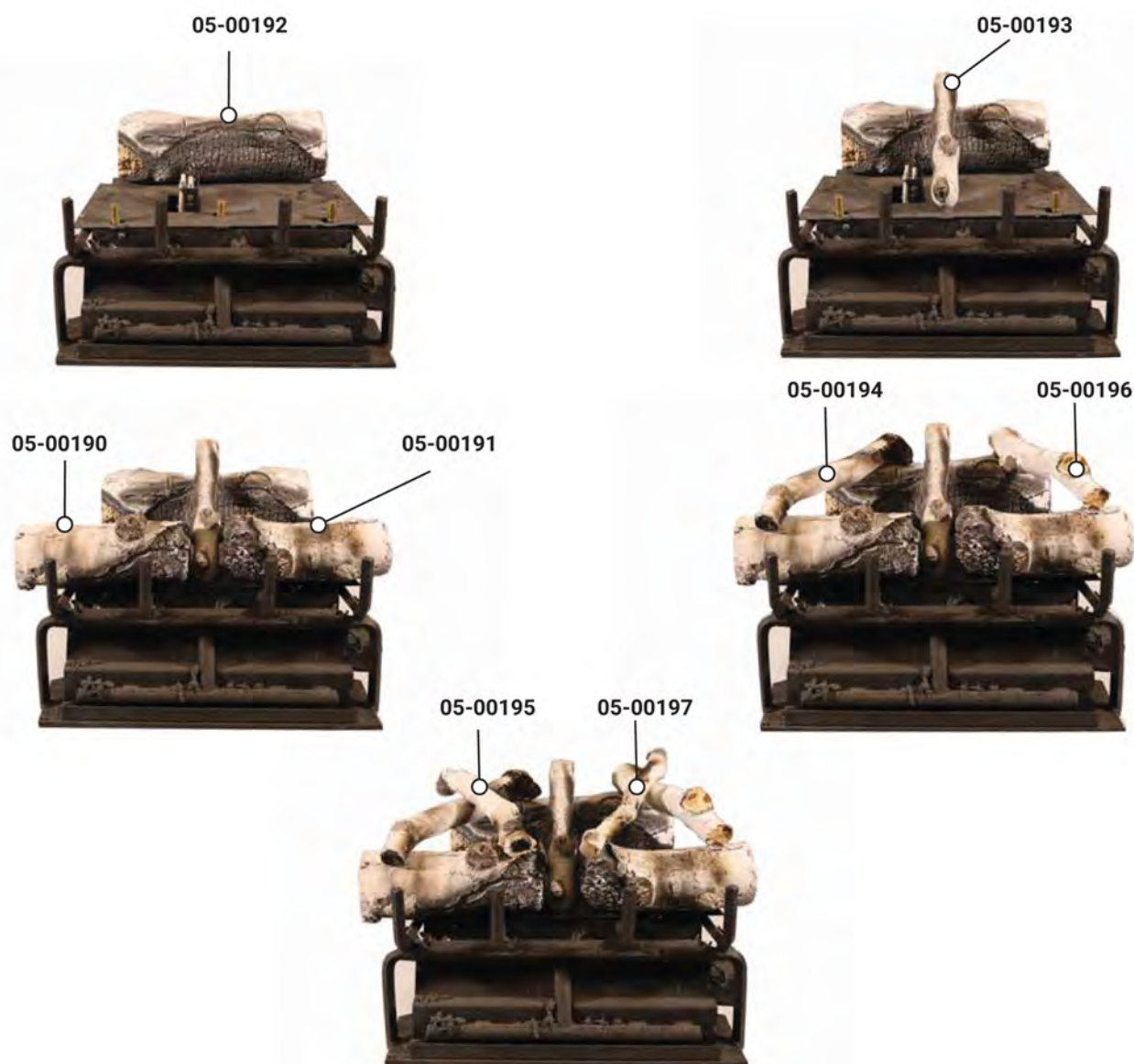

## 24" GLOWFIRE® ASPEN BIRCH CHARRED LOG PLACEMENT GUIDE

Part #	Description
GFBR24	24" Glowfire™ Aspen Birch Charred Log Set
05-00198	24" Front Left
05-00199	24" Front Right
05-00200	24" Back Log
05-00193	24" Middle Log
05-00201	24" Static Log #1
05-00195	24" Static Log #3
05-00202	24" Static Log #2
05-00196	24" Static Log #4

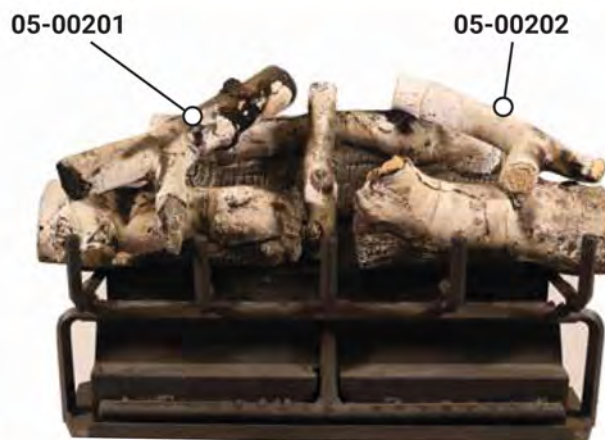

## 30" GLOWFIRE® ASPEN BIRCH CHARRED LOG PLACEMENT GUIDE

Part #	Description
GFBR30	30" Glowfire™ Aspen Birch Charred Log Set
05-00203	30" Front Left
05-00204	30" Front Right
05-00205	30" Back Log
05-00206	30" Middle Log
05-00207	30" Static Log #1
05-00202	30" Static Log #3
05-00195	30" Static Log #5
05-00208	30" Static Log #4
05-00209	30" Static Log #6
05-00210	30" Static Log #2

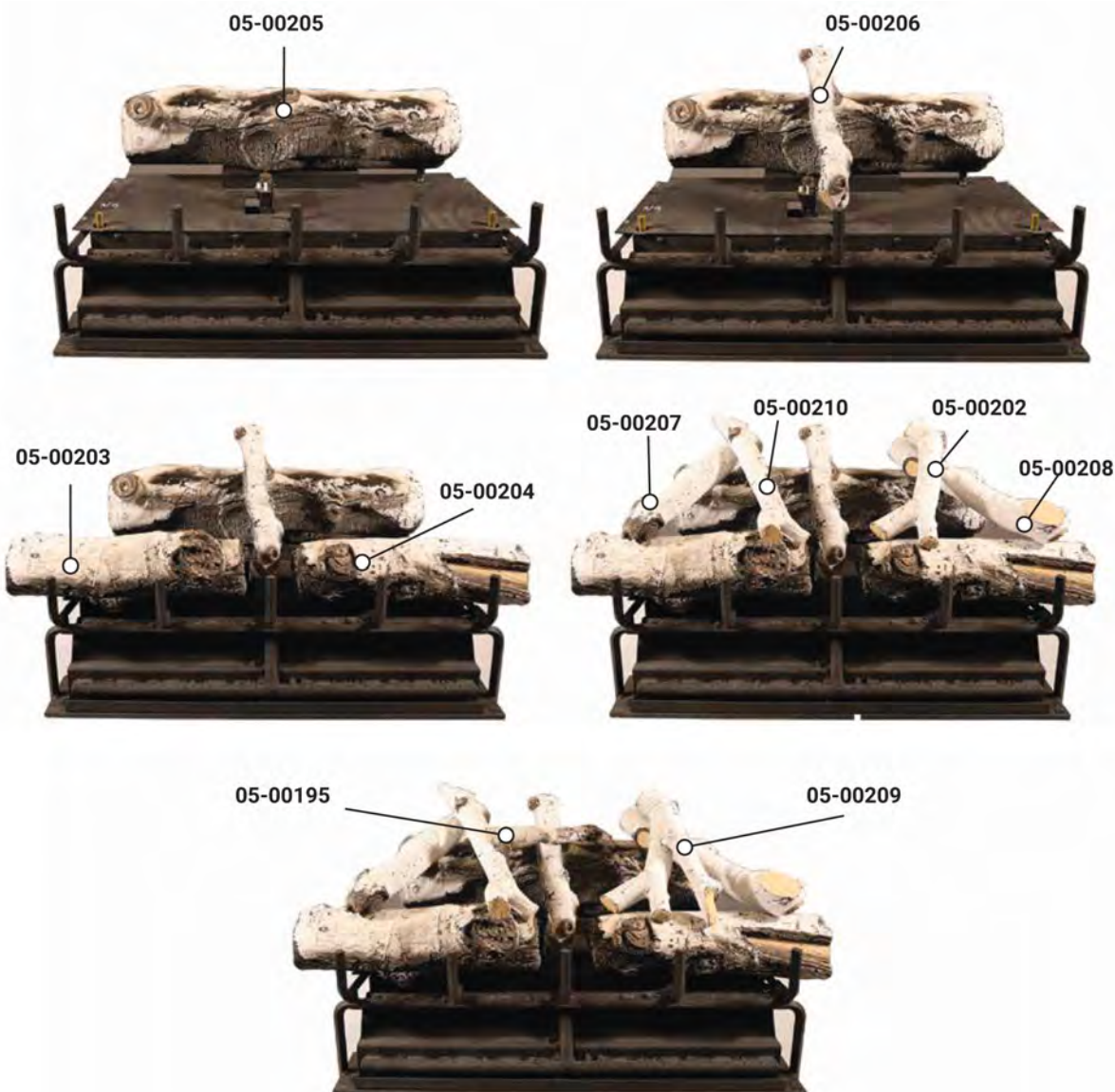

## 36" GLOWFIRE® ASPEN BIRCH CHARRED LOG PLACEMENT GUIDE

Part #	Description
GFBR36	36" Glowfire™ Aspen Birch Charred Log Set
05-00211	36" Front Left
05-00212	36" Front Right
05-00213	36" Back Log
05-00206	36" Birch Middle Log
05-00208	36" Static Log #1
05-00202	36" Static Log #3
05-00214	36" Static Log #5
05-00210	36" Static Log #2
05-00209	36" Static Log #6
05-00207	36" Static Log #4

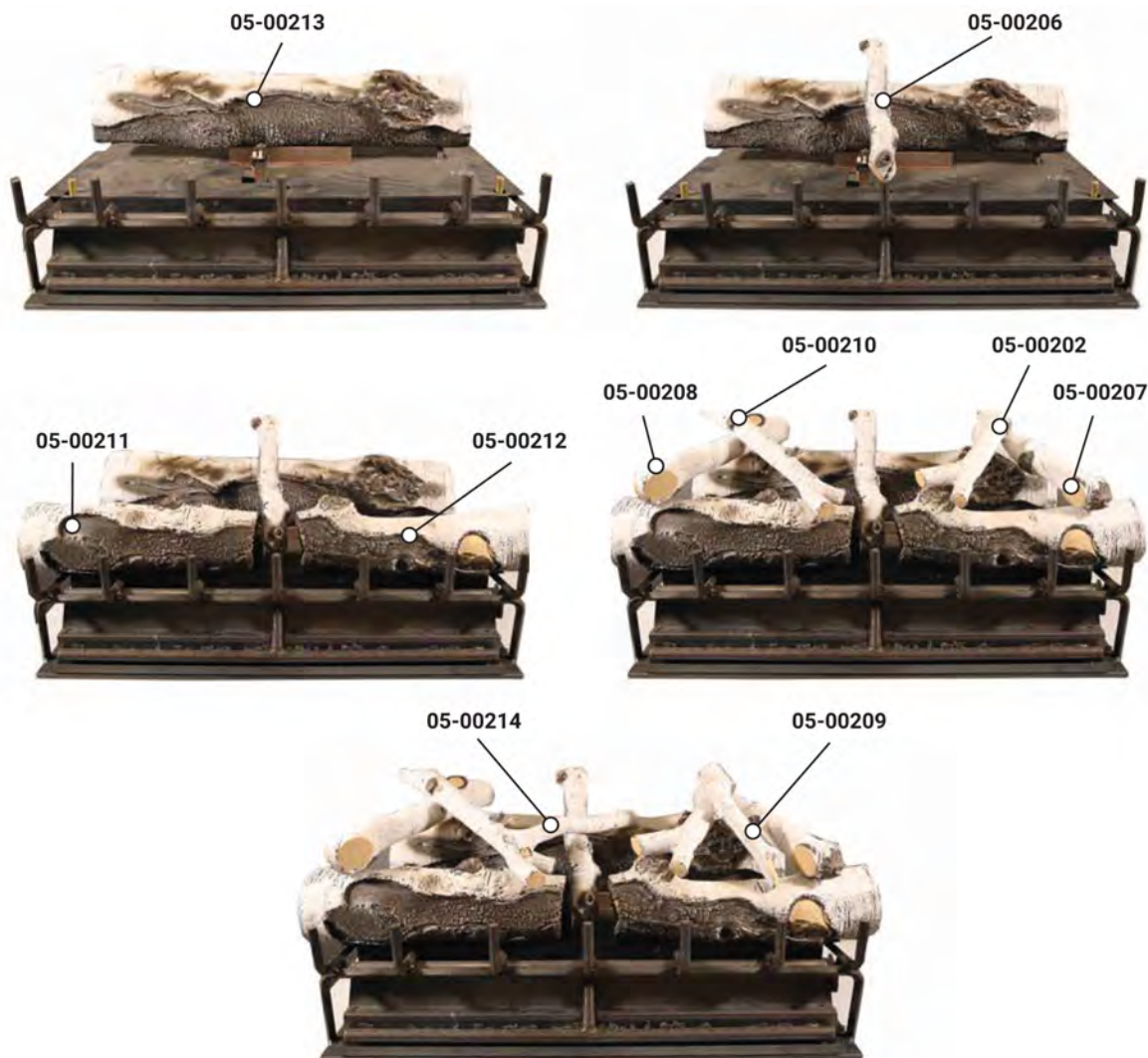

# OUTDOOR INSTALLATION REQUIREMENTS

Lava Burner Front View with Glowfire™ Logs from Grand Canyon Gas Logs have been tested and approved for installation outdoors under a patio cover and away from direct water contact or direct sun light. Grand Canyon Gas Logs standard warranty applies if installed per instructions. All electrical wiring shall be to local building codes. Consult professional installers before installation. Approved installations are as noted below.

## Front Protection:

Patio roof overhang must be 50% (or more) of the height of the patio roof from bottom of fireplace.

If:  $H=6'$

Then:  $OD=3'$  minimum ( $6' \times 50\%=3'$ )

Note 1: Base of fireplace must be 2" (minimum) above floor.

Note 2: H taken from bottom of fireplace.

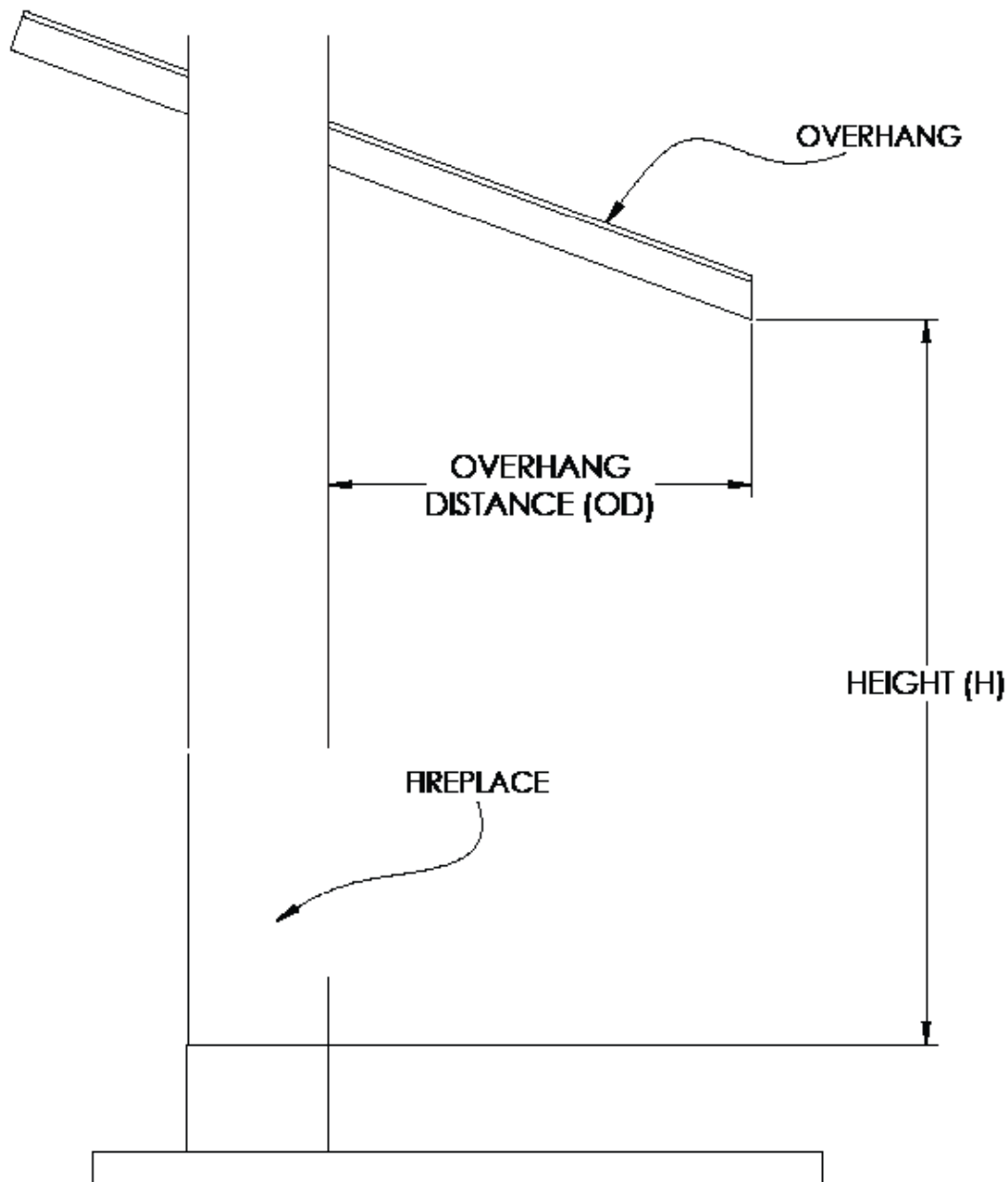

# OUTDOOR INSTALLATION REQUIREMENTS

## Side Protection:

Side distance (SD) must be 50% (or more) of the height (H).

If:  $H=6'$

Then:  $SD=3'$  minimum ( $6' \times 50\%=3'$ )

Note: H taken from bottom of fireplace.

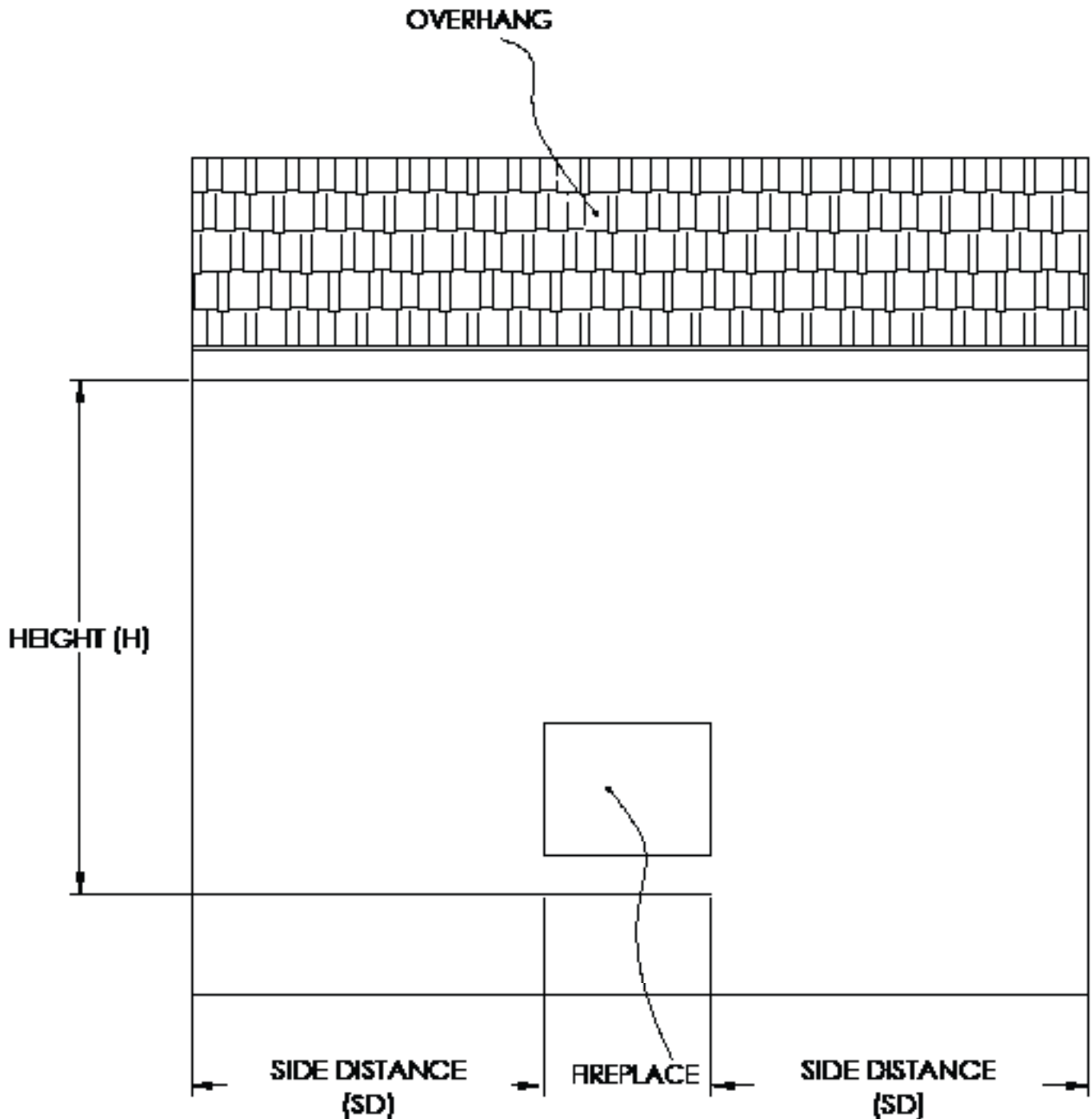

# MULTIFUNCTION REMOTE OPERATING INSTRUCTIONS

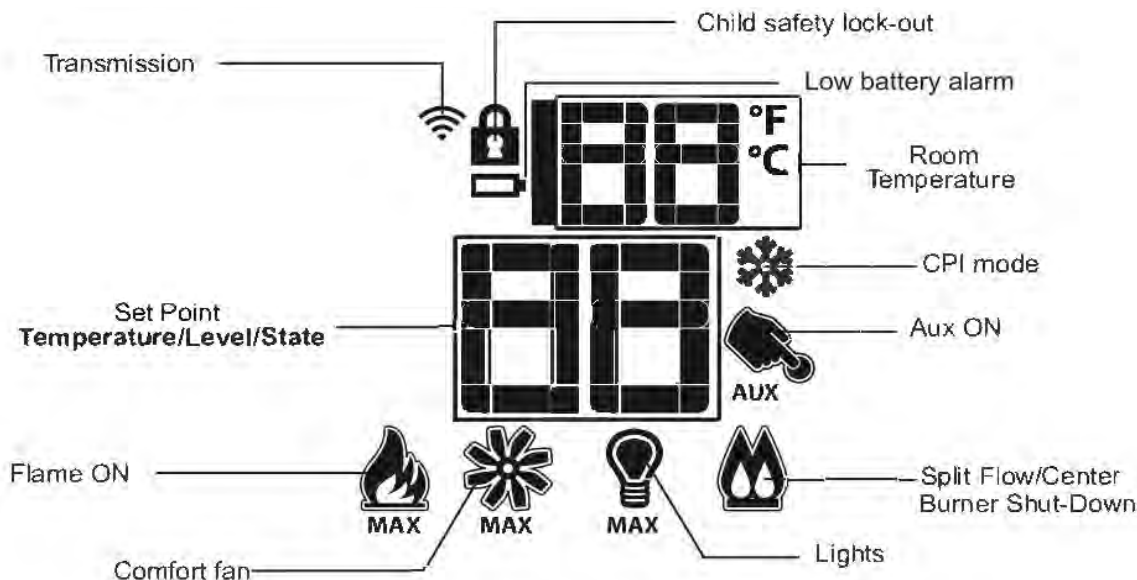

TECHNICAL DATA	
Remote Control	
Supply voltage	4.5 V (three 1.5 V AAA batteries)
Ambient temperature ratings	0-50°C (32 - 122°F)
Radio frequency	315 MHz

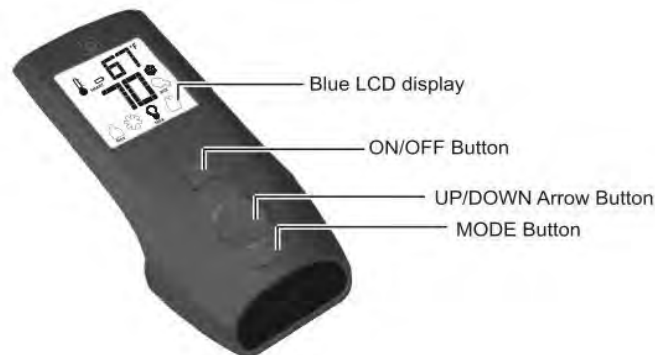

**⚠ WARNING:**  
The transmitter and receiver are radio frequency devices. Placing the receiver in or near metal may severely reduce the signal range.

**⚠ WARNING:**  
Turn off the main gas supply and electrical supply to the fireplace during installation and/or maintenance of the receiver device.

**⚠ WARNING:**  
**FIRE HAZARD**  
Can cause severe injury or death. The receiver causes ignition of the fireplace. The fireplace can turn on suddenly. Keep away from the fireplace burner when operating the remote system or activating manual bypass of the remote system.

**⚠ CAUTION:**  
**PROPERTY DAMAGE HAZARD**  
Excessive heat can cause property damage. The fireplace can stay lit for many hours. Turn off the fireplace if it is not going to be attended for any length of time. Always place the transmitter where children can not reach it.

**NOTICE:** Not all features called out in the diagram above are available on this fireplace.

**NOTICE:** This control system includes a Battery Back-up pack that allows the fireplace to operate in the event of a power outage.

**NOTICE:** The accent light and/or blower features will not operate during a power outage.

**NOTICE:** Replace all batteries at least once each year, preferably before at the beginning of the season.

**⚠ CAUTION:**  
**FIRE OR EXPLOSION HAZARD**  
Can cause property damage, sever injury or death. Do not attempt to take apart the gas control or to clean it. Improper assembly and cleaning can cause unreliable operation.

# MULTIFUNCTION REMOTE OPERATING INSTRUCTIONS

## Initializing the System for the First time (Re-Sync/Synchronize)

1. Open the receiver battery back up holder. **See Figure 7.1.** Install the four AA batteries into the battery back-up holder then reinstall the cover. **See Figure 7.2.**
2. Install three AAA batteries into the battery bay located on the base of the transmitter. **See Figure 7.3.**
3. Set the wall remote slide switch to the REMOTE position. **See Figure 7.2.**
4. Press and release the SWI button on the wall control with a paper clip and the IFC module will beep three times to indicate the IFC module is ready to synchronize with the transmitter within ten seconds. **See Figure 7.2.**



Figure 7.1



Figure 7.2

5. With the batteries already installed in the Transmitter, push the ON button. The receiver will beep four times to indicate the transmitter's command is accepted and sets to the matching code of the transmitter. The system is now initialized.

## Temperature Indication Display °C or °F

With the system in the OFF position, press the thermostat button and the mode button at the same time. Look at the LCD screen on the transmitter to verify that a °C or °F is visible to the right of the room temperature display. **See Figure 7.4 and 7.5.**



Figure 7.4



Figure 7.5



Figure 7.3

## D-cell battery replacement (Only LAVA SIT Systems)

This appliance uses a backup battery pack consisting of four (4) 1.5V D-cell batteries to support system operation during power interruptions. **See Figure 7.6.**

### Procedure

1. Turn the appliance OFF and allow it to cool completely.
2. Locate and remove the battery pack from the heat shield.
3. Disconnect the battery pack by gently unplugging the 2-pin wire connector if required.
4. Replace all four (4) 1.5V D-cell batteries.
5. Reconnect the wire harness securely.
6. Reinstall the battery pack into the heat shield and return it to its original position.

### Important Notes

- When replacing D-cell batteries, it is recommended to replace the receiver AA batteries at the same time.
- The system provides a low battery indication only for receiver batteries (double beep during operation).
- There is no low battery indicator for the D-cell battery pack.
- Replace all batteries as part of routine seasonal maintenance (Recommended).



Figure 7.6

# MULTIFUNCTION REMOTE OPERATING INSTRUCTIONS

## Turn On the Fireplace

With the system OFF, press the ON/OFF button on the transmitter. The transmitter display will show other active icons on the screen. At the same time the receiver will activate the fireplace. A single beep from the receiver will confirm reception of the command.

## Turn OFF the Fireplace

With the system ON, press ON/OFF button on the transmitter. The transmitter LCD display will only show the room temperature. **See Figure 7.6.** At the same time the receiver will turn off the fireplace. A single beep from the receiver confirms reception of the command.



Remote Control Display

## Remote Flame Control

The Proflame control has six flame levels. With the system on, and the flame level at maximum, each press the down arrow button once will reduce the flame height by one step - until the flame is turned off.

The up arrow button will increase the flame height each time it is pressed. If you press the up arrow button while the system is on but the flame is off, the flame will come on in the high position. **See Figures 7.7 and 7.10.** A single beep will confirm reception of the command.



Flame Off - Figure 7.7

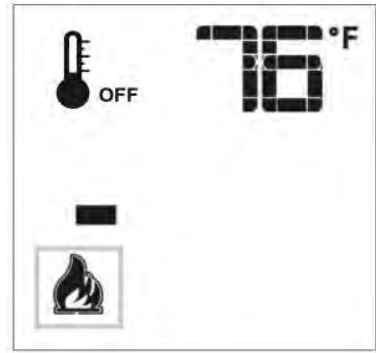

Flame Level 1 - Figure 7.8

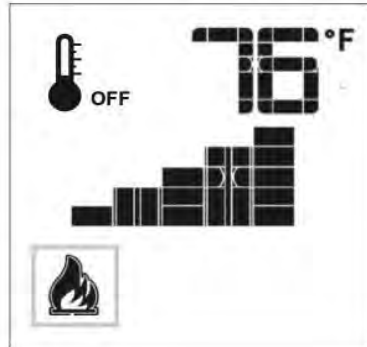

Flame Level 5 - Figure 7.9

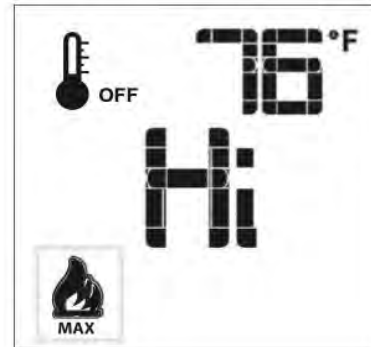

Flame Level Maximum - Figure 7.10

# MULTIFUNCTION REMOTE OPERATING INSTRUCTIONS

During a prolonged outage, the fireplace can operate in continuous pilot mode. This reduces drain on the batteries used to ignite the burner and ensures the fireplace will continue to operate throughout the outage.

## Continuous Pilot/Intermittent Pilot (CPI/IPI) Selection

With the system in OFF position press the Mode Button to index to the CPI mode icon. **Figure 7.11 and 7.12.** Pressing the up arrow button will activate the CPI. Pressing the down arrow button will return to IPI. A single beep will confirm the reception of the command.



Figure 7.11



Figure 7.12

## Button Lock

This function will lock the buttons to prevent unsupervised operation. To activate this function, press the MODE and UP buttons at the same time. **See Figure 7.13.**

To deactivate this function, press the MODE and UP buttons at the same time.



Figure 7.13

## Low Battery Power Detection - Transmitter

The life span of the remote control batteries depends on various factors:

- Quality of the batteries

- How frequently the fireplace cycles on and off

When the transmitter batteries are low, an icon will appear on the LCD display of the transmitter. **See figure 7.14** before all battery power is lost. When the batteries are replaced this icon will disappear.



Figure 7.14

## Using the Fireplace without a Remote Control

The fireplace can be turned ON (HI only) and OFF with wall switch. The fireplace flame ON/OFF is the only function that will operate; no flame adjustment, light or blower will work when using the wall switch. The wall control switch should be turned OFF when the fireplace is not being used for extended periods of time.

## Battery Backup Operation

Install batteries (See initialization sequence on page 28.) In case of power loss, the fireplace will switch to battery mode automatically. The fireplace will operate normally without the fan or light control when in battery mode.

## Low Battery Detection

When the backup batteries are low, the module emits a double beep when it receives an on/off command. The system will not accept any commands until the batteries are replaced or A/C power is restored.

## Lockout State Definition

To prevent damage to the fireplace, IFC board will automatically lockout the remote control if it detects an anomalous flame or too many unsuccessful ignition attempts. The lockout state will remain as long as the power supplies are applied.

When the IFC board goes into lockout state:

1. Both the Pilot and the Main Burner solenoids in the gas valve are deenergized;
2. A diagnostic code is sent through the diagnostic red LED.
3. The IFC board will ignore any burner ignition command and remain in the OFF state unless the unlock command sequence is met.

Turn the system power supplies (to the wall control or remote control) OFF for two or three seconds and then restore power. If the lockout reoccurs, call your dealer. The causes of lockout must be investigated under safe conditions by trained service personnel.

## GCRK

### Manual On/Off Remote Control with Timer for Dexen Valve Installation and Operating Instructions

**IF YOU CANNOT READ OR UNDERSTAND THESE INSTALLATION INSTRUCTIONS. DO NOT ATTEMPT TO INSTALL OR OPERATE**

This manual on/off remote control with timer transmitter is designed to be used with millivolt valve gas appliances. It can be operated on/off from the transmitter or turned on and off manually from the receiver.

### CONTENTS OF KIT

Description	Quantity
Transmitter	1
GCRK Timer remote control Transmitter	1
Receiver Box	1
Slide Button-Black and White Color (On/RS/Off)	2
Wall Cover Plate-Black and White Color	2
Battery Door- Black and White Color	2
Plug-In Wiring Assembly – 22" Inches	1
Installation Instructions	1
#6 3/4 Screws (for Wall Cover Plate and Remote control) #6 3/4 Screws (for fireplace system control covers)	4
Plastic wall anchors (for installing transmitter)	2
	2

**NOTE:** Due to the sensitive temperature monitoring components in the transmitter, it is necessary to allow the transmitter to stabilize to room temperature before accurate room temperature are displayed, If the transmitter is activated from a severe cold condition allow 15 minutes for accurate temperature reading to appear on the LCD.

### WARNING

#### Important Safety Information

- Read this manual thoroughly prior to installing, programming, or operating any remote control.
- This remote control system is designed for use with a millivolt or 24V gas valve system. Do not use this remote control system on applications with voltages above 24 Volts AC/DC and 1 amp current.
- This remote control system requires two (2) "AAA" and four (4) "AA" alkaline batteries to power the transmitter and receiver.
- **Turn appliance OFF (at the appliance or remote receiver) if you are away from your house for a long period of time.**

### FEATURES/SPECIFICATIONS

- Easy Operate Manual on/off and Timer Control
- Battery Powered Transmitter and Receiver
- Low Battery Indication
- Select Between °C and °F display
- Child Proof Lock-out
- 16 Security Codes
- Quick Disconnect Wiring Assembly

**⚠ WARNING: Turn appliance OFF and allow to cool before installing or servicing. DO NOT connect 110-120 VAC wiring to the millivolt gas control valve. The remote operator must be installed exactly as outlined in these instructions. Read all instructions completely before attempting installation. Follow instructions carefully during installation. Any modification of components will void the warranty and may cause a fire hazard.**

# REMOTE CONTROL INSTRUCTIONS

## Transmitter:

### Installing Batteries:

1. Press down the battery door and remove the battery door.
2. Install uses two (2) "AAA" batteries as indicated on transmitter.
3. Close the battery door by snapping in place.
4. The batteries should be replaced when the low battery indicator display in LCD.
5. When both batteries are installed, the transmitter will initialize for 1 seconds and then is ready for use.

### LEARNING TRANSMITTER TO RECEIVER :

1. The transmitter privacy (DIP) switches are preset at the factory. Setting the 4 bits DIP switches on transmitter to select a security code.
2. Put the receiver slide switch to "RS" location. Using a small screwdriver or end of a paper clip gently press and Hold the 'LEARN' button on the receiver to accept the transmitter security code upon initial use, When you release the LEARN button the receiver will emit an audible 3 "beep" sounds.
3. After the receiver emits 3 "beep" sounds. Press the transmitter "ON "or "OFF" button and release at once. The receiver will emit several beeps indicating that the transmitter's code has been accepted into the receiver.
4. If you are unsuccessful in matching the security code on the first attempt repeat step 1-3.

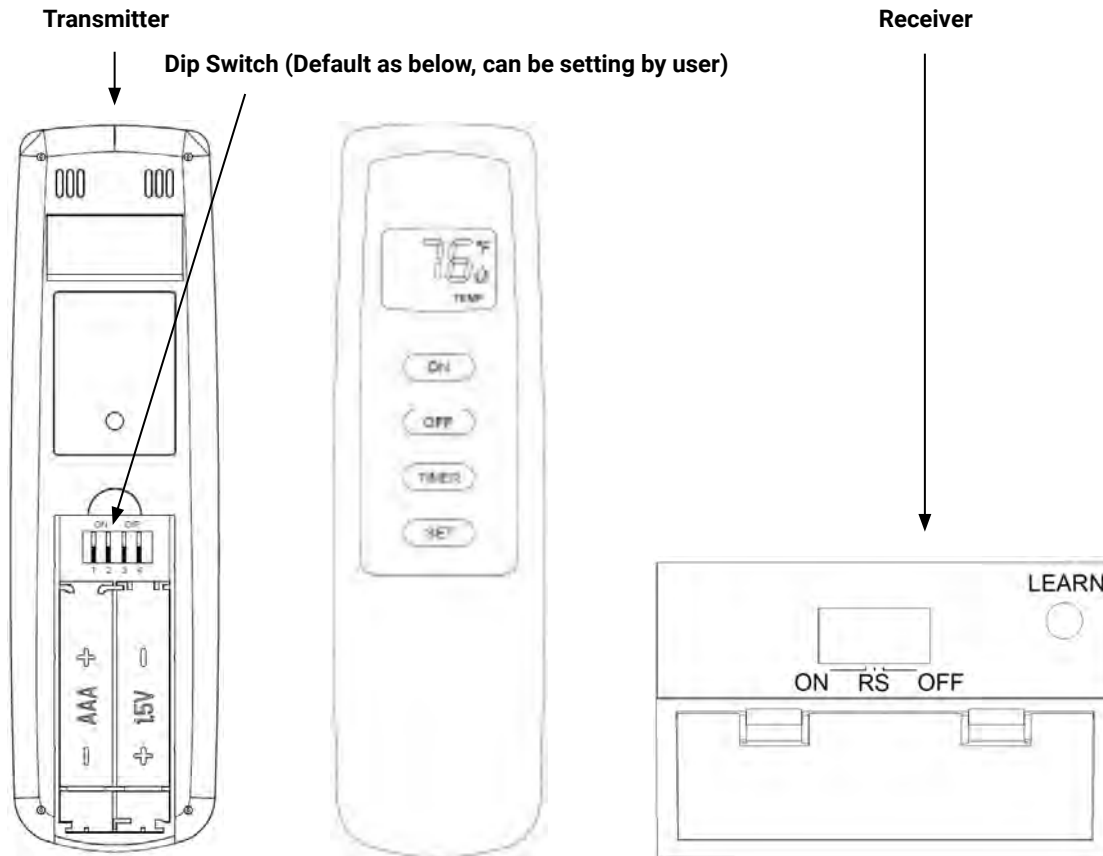

### KEY SETTINGS

1. **ON** - - - - - Turns appliance ON
2. **OFF** - - - - - Turns appliance OFF
3. **TIMER** - - - Changes unit from manual mode to timer mode
4. **SET** - - - - - Adjusts timer setting

**⚠ WARNING: Do not use two (2) or more remote control systems in the same area with the same dip switch settings, as they will communicate with each other. This may cause the appliances to malfunction.**

## OPERATIONS:

The GCRK remote control has two (2) operating modes: Manual and Timer. (15 min. -180 min. in 15 minute increments). The max setting time is 180 min.

The transmitter will operate the remote receiver from 1 foot to 30 feet. The distance is reduced when batteries are low or when the receiver is inside a metal enclosure.

### Initial Start Up:

1. After initial power up the transmitter is reset.
2. During system reset, all features of the LCD will be visible. After one second, the LCD will be initialized. A typical reset display is shown right. After reset the transmitter is operating. The real room temperature is shown as right.

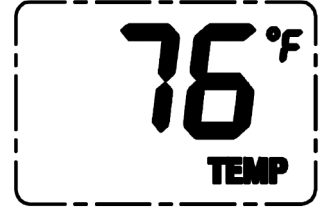

### Manual Mode:

1. Press the "ON" button once to turn on the appliance.
2. Press the "OFF" button once again to turn off the appliance.
3. Press "ON" and "OFF" button at same time for 1 second to select between °C and °F display.

### Timer Mode:

1. Press the "ON" button to start the appliance
2. Press the "TIMER" button. The LCD screen will show the word 'SET'.
3. Press the "SET" button until the desired time is reached (15min-180min. in 15minute increments.) The max setting time is 180 min.
4. Press the "OFF" button to turn OFF the timer, and the appliance.



### Low-Battery Detection:

1. When the battery voltage of remote less than 2.2V, the low battery icon will appear on the LCD screen. The battery will be checked every 3 minute. If the battery voltage of remote is less than 1.8V, the remote will send the flame off command to the receiver and only low battery icon display on the LCD, change the battery before the battery is too weak for normal operation.

**TURN THE UNIT OFF BEFORE REPLACING BATTERIES.**



### Child-Proof Protection:

1. Press and Hold "ON" and "MODE" button at same time for 5 seconds to activate child-proof mode. The letters CP will appear in the TEMP frame on the LCD screen.
2. The remote control will not work until child-proof mode is deactivated by pressing the "ON" and "MODE" buttons at same time for 5 seconds again to exit child-proof mode.

### Transmitter Wall Clip

The transmitter can be hung on a wall using the clip provided. If the clip is installed on a solid wood wall, drill 1/8" pilot holes and install with the screws provided. If it is installed on a plaster/wallboard wall, first drill two 1/4" holes into the wall. Then use a hammer to tap in the two plastic wall anchors flush with the wall; then install the screws provided.

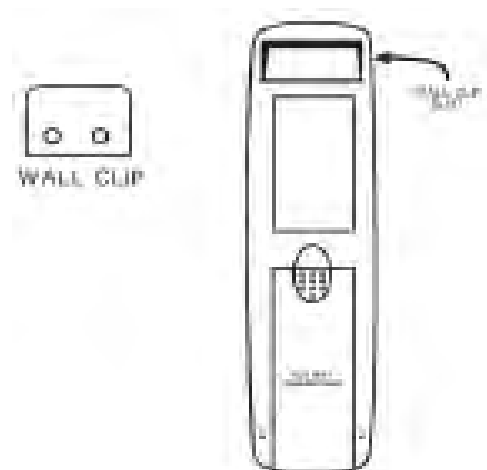

# REMOTE CONTROL INSTRUCTIONS

**⚠ WARNING:** Make sure that the wires do not contact the appliances any place other than at the terminals. Exposure to temperatures higher than 250° (105°) may cause the receiver to malfunction or cause a fire hazard.

## RECEIVER:

**Begin by installing** (4) AA-size batteries. Slide open the battery cover on receiver. It is recommended that ALKALINE batteries always be used for this product. Be sure the batteries are installed with the (+) and (-) ends facing the correct direction. Close battery cover.

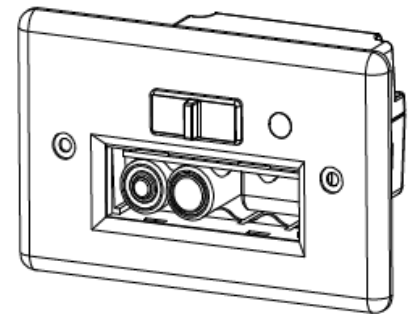
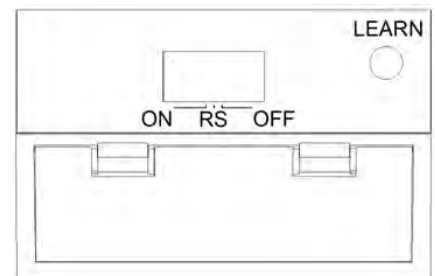

## Installation

The remote receiver can be either wall-mounted in a standard plastic switch box (not metal) or placed on or near the fireplace hearth. Preferably, the remote receiver should be wall-mounted in a plastic switch box, as this will protect its electronic components from the heat produced by the gas appliance. The remote receiver should be kept away from temperatures exceeding 130° F. Battery life is also significantly shortened if batteries are exposed to temperatures 130°F or higher. Before installation make sure the remote receiver slide switch is in the OFF position.

## Wall Mount

When wall mounting the remote receiver, longer wires (not included) are required to connect to the gas valve or electronic module. These wires must: Be at least 18 Gauge (AWG).

## Hearth Mount

The remote receiver may be placed on the fireplace hearth or under the fireplace behind the control access panel. Use the wires attached to the remote receiver to connect to the gas valve or an on/off switch (included piggyback connectors have both male & female terminals for flexibility). Be sure that the connectors do not touch each other or other bare metal surfaces.

# REMOTE CONTROL INSTRUCTIONS

## Slide Switch:

1. **ON position:** The system will remain on until the slide switch is placed in the OFF or REMOTE position.
2. **REMOTE position:** The system will only operate if the remote receiver receives a signal from the transmitter.
3. **OFF position:** The system is off. **The slide switch should be placed in the OFF position if you will be away for an extended period of time.** If the remote receiver is mounted out of children's reach, the OFF position also functions as a safety device by both turning the system off and rendering the receiver inoperable.

## Testing Your New Remote System

1. Light your gas appliance following the appliance lighting instructions that come with the appliance. Confirm that the pilot light is on; it must be in operation for the remote control to operate the main gas valve. Appliance control knob must be in the ON position. Appliance ON/OFF switch must be in ON position.
2. Slide the 3 position button on the remote receiver to the ON position. The main gas flame should ignite.
3. Slide the button to OFF. The flame should extinguish (the pilot light will remain on).
4. Slide the button to REMOTE (the center position), then press the transmitter to turn the system to ON. The main gas flame should ignite.
5. Press the transmitter to turn the system to OFF. The flame should extinguish (the pilot light will remain on.)

## TROUBLESHOOTING

Symptom	Causes	Action
Battery icon on LCD on transmitter	Low Battery	Replace batteries
LCD display is blank	Low Battery	Check battery installation and replace batteries
Receiver emits the beep in every minute	Low Battery	Replace batteries
Appliance does not come on	1. DIP (Privacy) switch setting on transmitter does not match receiver	1. Make sure the transmitter match receive at first
	2. Transmitter measures temperature exceeding 99 degrees and shows "HI" on LCD display	2. Move transmitter to a cooler place and wait until temperature drops below 99 degrees
	3. Distance between the transmitter and receiver is more than 30 feet	3. Make sure the operating distance is less than 30 feet
Receiver cannot receive signal	1. Receiver is installed in an enclosure	1. Make sure the receiver is not inside a tight enclosure

# INTERMITTENT PILOT INSTRUCTIONS

## FOR YOUR SAFETY READ BEFORE LIGHTING

### ⚠ WARNING

If you do not follow these instructions exactly, a fire or explosion may result causing property damage, personal injury or loss of life.

**A. BEFORE LIGHTING** smell all around the appliance area for gas. Be sure to smell next to the floor because some gas is heavier than air and will settle on the floor.

#### WHAT TO DO IF YOU SMELL GAS

- Do not try to light any appliance.
- Do not touch any electrical switch.
- Do not use any phone in your building.
- Immediately call your gas supplier from a neighbor's phone. Follow the gas supplier's instructions.
- If you can not reach your gas supplier, call the fire department.

**B.** Use only your hand to push in or turn the gas control knob. Never use tools. If the knob will not push in or turn by hand, don't try to repair it, call a qualified service technician. Force or attempted repair may result in a fire or explosion.

**C.** Do not use this appliance if any part has been under water. Immediately call a qualified service technician to inspect the appliance and to replace any part of the control system and any gas control which has been under water.

## LIGHTING INSTRUCTIONS

1. **STOP. Read the Safety information above this label.**
2. Read the Care and Operation manual on page 27.
3. Turn appliance's gas shutoff Valve to the ON position.
4. Wait five (5) minutes to clear air from fuel lines. Then smell for gas, including near the floor. If you smell gas, STOP! Follow "B" in the safety information above on this label. If you don't smell gas, go to next step.
5. Press ON/OFF with your Proflame II remote control Transmitter.
6. Listen for the receiver's audio feedback. A single Beep will be heard.
7. The appliance will begin to light.
8. This device is equipped with an ignition device which automatically lights the pilot.
9. Do not try to light the pilot by hand.
10. If the appliance will not operate, follow the instructions "Shutdown instructions" and call your service technician or gas supplier.

Electronic Gas Control Valve - SIT Proflame

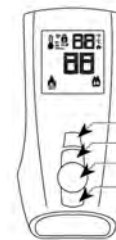

Remote Control Transmitter

- ON/OFF Key
- THERMOSTAT Key
- UP/DOWN Arrow Key
- MODE Key

Vent Free Pilot Assembly



Vented Pilot Assembly

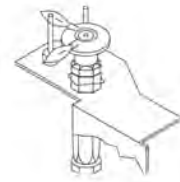

## TO TURN OFF GAS TO FIREPLACE

1. Press ON/OFF on your Proflame II remote control transmitter.
2. Listen for the receivers audio feedback. A single beep will be heard.
3. Appliance will begin to turn off.
4. Extreme temperatures caution. Do not attempt to touch any surface of the bedrock system until adequate time for cooling is conducted.
5. Adequate time varies on, size of bedrock, duration of use, and outside temperatures.
6. Turn appliance's gas shutoff valve to the Off position.
7. Turn of appliance's breaker, if service is to be performed.
8. **In case of an Emergency or access to Proflame II remote transmitter is lost.**  
Bypass Proflame II remote control transmitter and move directly to gas shutoff valve. Turn valve to off position.

# BATTERY LIGHTING INSTRUCTIONS

## FOR YOUR SAFETY READ BEFORE LIGHTING

**WARNING:** If you do not follow these instructions exactly, a fire or explosion may result causing property damage, personal injury or loss of life.

- A. This appliance is equipped with an ignition device that automatically lights the pilot. **DO NOT** attempt to light the pilot by hand.
- B. **BEFORE OPERATING**, smell all around the appliance area for gas. Be sure to smell next to the floor because some gas is heavier than air and will settle on the floor.
- WHAT TO DO IF YOU SMELL GAS**
- Do not light any appliance.
  - Do not touch any electric switch; do not use any phone in your building.
  - Immediately call your gas supplier from a neighbor's phone. Follow the gas supplier's instructions. If you cannot reach your gas supplier, call the fire department.
- C. Use only the remote to light the pilot. This valve will not operate if the pilot is not lit and stable.
- D. Do not use this appliance if any part has been under water. Immediately call a qualified service technician to inspect the appliance and to replace any part of the control system and any gas control which has been under water. Attempted operation may result in fire or explosion resulting in property damage, personal injury or loss of life.

## REMOTE LIGHTING

**CAUTION:** DO NOT attempt to light the pilot by hand.

**Note:** If the remote does not function, and batteries with an adequate power level are installed, refer to the TRANSMITTER FUNCTION section.

**Note:** Step 1 may not be required if previously done during an early lighting.

1. Locate the 3-position switch on the remote receiver and slide the switch to the REMOTE position.
2. Locate the remote transmitter and press the ON button. The ignition sequence will begin. The remote receiver will emit an audible "beep"; then the igniter will begin to spark. After the pilot lights and is established, the valve will automatically open and the burner will light.

**Note:** The ignition sequence will take approximately 5 seconds.

**WARNING:** If the pilot fails to light or if the burner fails to light (within 5 seconds of pilot lighting), press the OFF button on the remote transmitter and/or slide the switch to the OFF position. Allow five (5) minutes for any gas in the unit to dissipate, then repeat steps 1 and 2 above. **IF YOU SMELL GAS, SEE STEP B ABOVE.**

If the pilot fails to light after several tries, turn all control/remote system components to OFF and contact a qualified professional service technician.

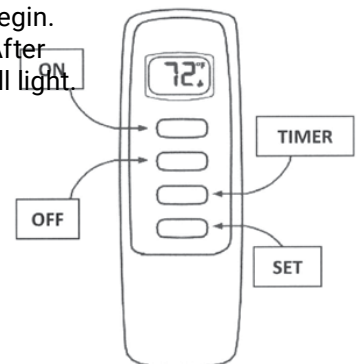
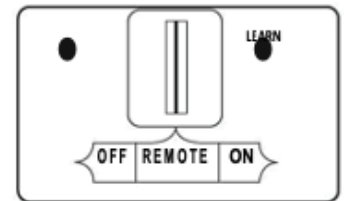

## SHUTTING DOWN

**For remote shut down**, press the OFF button on the remote transmitter.

**If remote is unavailable**, slide the switch on the remote receiver to the OFF position.

### PILOT APPEARANCE

Periodically check the pilot for proper flame pattern. The pilot flame should encircle the generator tip, and is reset at the factory.

**If the pilot flame burns incorrectly; shut down completely and contact a qualified professional technician.**



Battery Pilot

## WARNING

- Turn off the gas and electrical power before servicing the appliance.
- Appliance may be hot. Do not service until appliance has cooled.
- Do not use abrasive cleaners on glass.
- Do not paint the pilot assembly.

This appliance and its venting system should be inspected before use and at least annually by a qualified service person. The following suggested checks should be performed by a qualified technician. The appliance area must be kept clear and free of combustible materials, gasoline, or other flammable vapors and liquids. The flow of combustion and ventilation air must not be obstructed.

### NOTE:

**Caution:** Label all wires prior to disconnection when servicing controls. Wiring errors can cause improper and dangerous operation. Verify proper operation after servicing.

1. In order to properly clean the burner and pilot assembly, remove the glass to expose both assemblies.
2. Keep the control compartment, media, burner, air shutter opening, and the area surrounding the appliance clean by vacuuming or brushing, at least once a year.
3. Check to see that all burner ports are burning. Clean out any of the ports which may not be burning or are not burning properly.
4. Check to see that the pilot flame is large enough to engulf the flame sensor and/or thermocouple/thermopile as well as it reaches the burner.
5. If your appliance is equipped with a safety barrier, cleaning may be necessary due to excessive lint / dust from carpeting, pets, etc. Simply vacuum using the brush attachment.
6. If your appliance is equipped with relief doors, ensure the system performs effectively. Check that the gasket is not worn or damaged. Replace if necessary.
7. Replace the cleaned glass. Failure to properly position the media may cause carboning which can be distributed in the surrounding living area, inside the firebox and on exterior surfaces surrounding vent termination.
8. Check to see that the main burner ignites completely on all ports when turned on a 5 to 10 second total light-up period is satisfactory. If ignition takes longer, consult your local authorized dealer/distributor.
9. Visually inspect the appliance for carbon build up. Using a small whisk or brush, brush off the carbon and vacuum up or sweep into garbage.
10. **This step is not applicable for vent free appliances:** Check to see that the appliance is venting correctly. Ensure chimney system is safe and unobstructed. (If for any reason the vent air intake system is disassembled, re-install and reseal per the instructions provided for the initial installation).
10. **Log care.** Ceramic logs are fragile. Handle with care. Chipping and flaking is normal and can be easily touched up.

Symptom	Problem	Test Solution
Pilot will not light and / or makes noise with no spark at pilot burner	Battery	- Check batteries.
	Wiring	- Verify the wire for the sensor and the wire for the igniter are connected to the correct terminals (not reversed) on the module. <b>NOTE: Sensor has 3/16" (4.8mm) connection and igniter has 1/8" (3.2mm) connection.</b>
	Loose connection	- Verify no loose connections, electrical shorts in the wiring or ground out to any metal object.
	Module	- Turn the ON/OFF switch to the "OFF" position. Remove the igniter wire from the module. Place the ON/OFF switch to the "ON" position. Hold a grounded wire about 3/16" (4.8mm) away from the igniter (spark) terminal on the module. If no spark the igniter terminal module must be replaced. If there is a spark the igniter terminal is fine.
	Igniter spark gap is incorrect	- Spark gap of the igniter to the pilot should be 1/8" (3.2mm).
	Electrode	- Inspect pilot assembly for a shorted wire or cracked insulator around the electrode.
	A shorted or loose - connection	- Remove and reinstall the wiring harness that plugs into the module. Remove and verify continuity of each wire in wiring harness.
	Improper switch wiring	- Troubleshoot the system with the simplest ON/OFF switch.
	Module is not grounded	- Verify the valve and pilot assemblies are properly grounded to the metal chassis of the appliance.
Pilot sparks but will not light	Gas supply	- Verify that the incoming gas line ball valve is "Open". Verify that the inlet pressure reading is within acceptable limits, inlet pressures must not exceed 14" W.C. (34.9mb).
	Out of propane gas	- Fill the tank.
Carbon is being deposited on glass, media or combustion chamber surfaces	Air shutter has become - blocked	- Ensure air shutter opening is free of lint or other obstructions.
	Flame is impinging on the - glass, media, or combustion chamber	- Check that the glass, logs, rocks, or media are correctly positioned. Open air shutter to increase the primary air. Check the input rate: check the manifold pressure and orifice size as specified in the instructions.

# TROUBLESHOOTING

Symptom	Problem	Test Solution
Continues to spark and pilot lights, but main burner will not light	Short or loose connection in sensor rod	<ul style="list-style-type: none"> <li>– Verify all connections. Verify the connections from the pilot assembly are tight; also verify these connection are not grounding out to any metal.</li> </ul>
	Poor flame rectification or contaminated sensor rod	<ul style="list-style-type: none"> <li>– Verify the flame is engulfing the sensor rod. This will increase the flame rectification. Verify correct pilot orifice is installed and inlet gas specifications to manual. (Remember, the flame carries the rectification current, not the gas. If the flame lifts from the pilot hood, the circuit is broken. A wrong orifice or too high of an inlet pressure can cause the pilot to lift.) The sensor rod may need cleaning.</li> </ul>
	Poor grounding between pilot assembly and gas valve	<ul style="list-style-type: none"> <li>– Verify that the wire harness is firmly connected to the module. Verify that the ceramic insulator around the sensor rod is not cracked, damaged, or loose. Verify the connection from the sensor rod to the sensor wire.</li> </ul>
	Damaged pilot or sensor rod	<ul style="list-style-type: none"> <li>– Clean sensor rod with an emery cloth to remove any contamination that may have accumulated on the sensor rod. Verify continuity with multimeter with ohms set at the lowest range. Check for shorted wire or cracked insulator.</li> </ul>
	Pilot has been painted	<ul style="list-style-type: none"> <li>– Using a piece of sandpaper or emery cloth, remove the paint from the pilot hood, igniter and flame sensor.</li> </ul>
	Wiring / connection	<ul style="list-style-type: none"> <li>– Inspect all wires, ensure good tight connections. Verify that all wiring is installed exactly as specified.</li> </ul>
	Wiring harness	<ul style="list-style-type: none"> <li>– Inspect the wiring harness, and verify the harness is tightly connected to the module. Verify that all wires are connected in the right order. See “wiring diagram” section.</li> </ul>
Pilot lights. Stops sparking / pilot remains lit but burner will not turn on	Pilot has been painted	<ul style="list-style-type: none"> <li>– Using a piece of sandpaper or emery cloth, remove the paint from the pilot hood, igniter and flame sensor.</li> </ul>
Exhaust fumes smells in room, headaches	Appliance is spilling	<ul style="list-style-type: none"> <li>– Check that chimney is installed to building code. Room is in negative pressure; increase fresh air supply. Check damper positioning. Check for chimney blockage.</li> </ul>

## **Burner:**

Grand Canyon Gas Logs burners carry a life time warranty against manufacture defects or breakage as long as the appliance is installed inside and by a professional installer. In the event a defect or breakage occurs a replacement will be available for pick-up from the dealer at which the burner was originally purchased. This warranty is limited to original purchaser only. Indoor burners installed outside carry a (1) year warranty.

## **Electrical and Valves:**

Grand Canyon Gas Logs valves, remotes, and receivers carry a (2) year warranty against breakage or defects from date of purchase, by original purchaser, and must be installed by a licensed professional installer. This warranty only covers use with Grand Canyon Gas Logs burners and logs. In the event a defect or breakage occurs a replacement will be available for pick-up from the dealer at which the burner was originally purchased. Batteries are not covered under this warranty. ODS pilot assemblies carry a (1) year warranty.

## **GlowFire™ Logs:**

GlowFire™ Logs are manufactured with ceramic fiber and carry a 5 year warranty when installed indoors and a 2-year warranty when installed outdoors. The warranty covers any manufacture defects or breakage as long as the products are installed correctly. This warranty does not cover color fading due to use. In the event defect or breakage occurs, a replacement will be available to pick up from the dealer at which the log set was originally purchased or shipped directly to the customer if ordered online. This warranty does not cover breakage caused by excessive handling once installed and fired. This warranty is limited to original purchaser only.

**SCAN QR CODE FOR WARRANTY FORM**



# DO NOT RETURN TO STORE!



## STOP CALL US FIRST

For immediate help with installation, product information or if your product arrives damaged, please call our toll free number at:

# 1-602-344-4217

(Monday - Friday, 8:00AM - 5:00PM, AZ Mountain Time)

or email us at:  
[customerservice@grandcanyongaslogs.com](mailto:customerservice@grandcanyongaslogs.com)

## OUR STAFF IS READY TO PROVIDE ASSISTANCE

Copyright 2026 All rights reserved U.S.A, and Foreign Patents Pending.

052026